

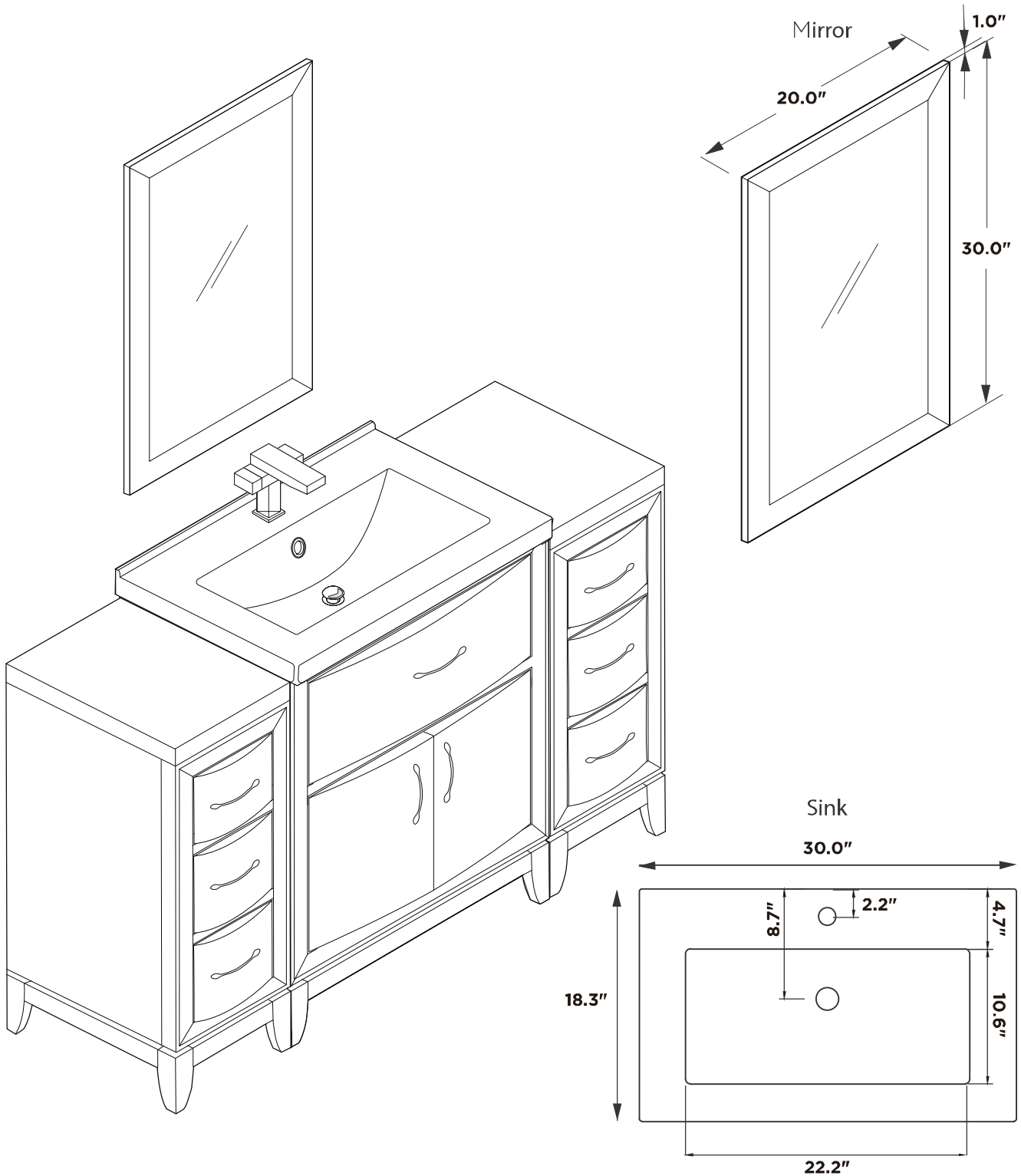

FVN21-123012
CAMBRIDGE
INSTALLATION GUIDE

kitchensource.com
 1.800.667.8721



Note: All dimensions and specifications are approximate and subject to change without notice.



FVN21-123012
CAMBRIDGE
INSTALLATION GUIDE

kitchensource.com
 1.800.667.8721



Vanity Front

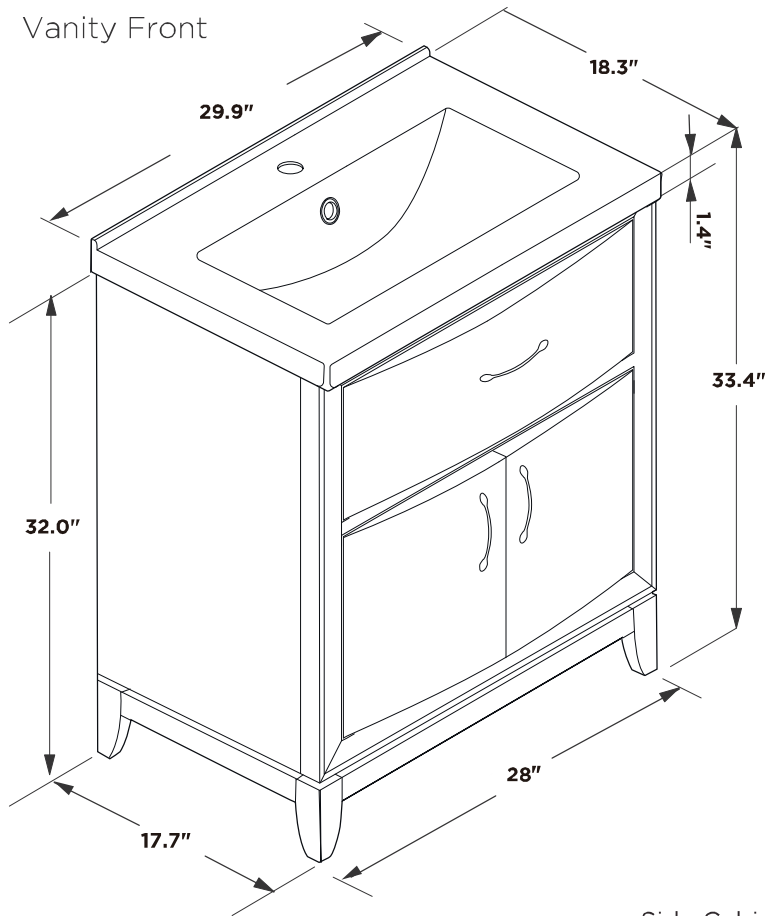

Vanity Back

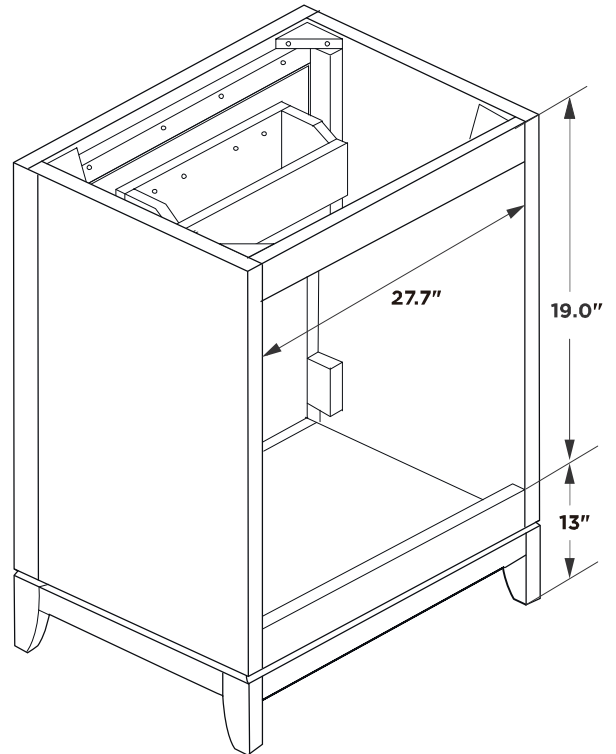

Side Cabinet Back

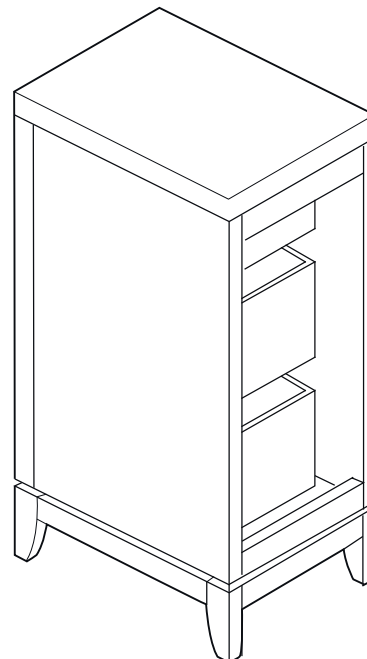
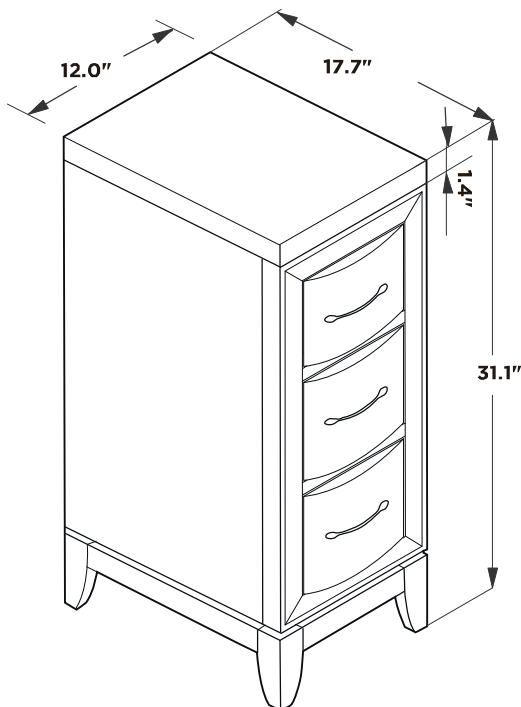

MIRROR INSTALLATION INSTRUCTION

TOOLS FOR ASSEMBLY

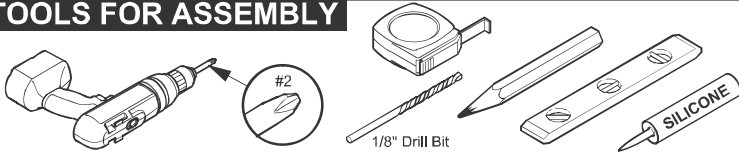

- 1** Measure the distance between the brackets on the back of the mirror

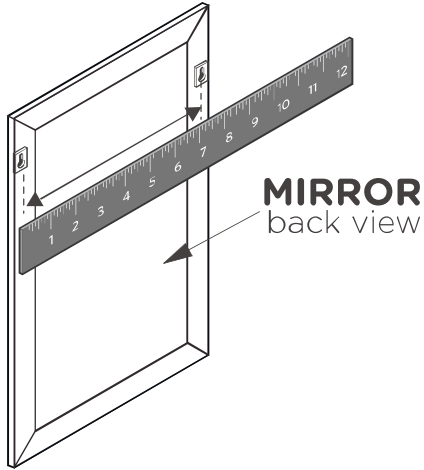

- 2** Mark the measured distance on the wall using a level

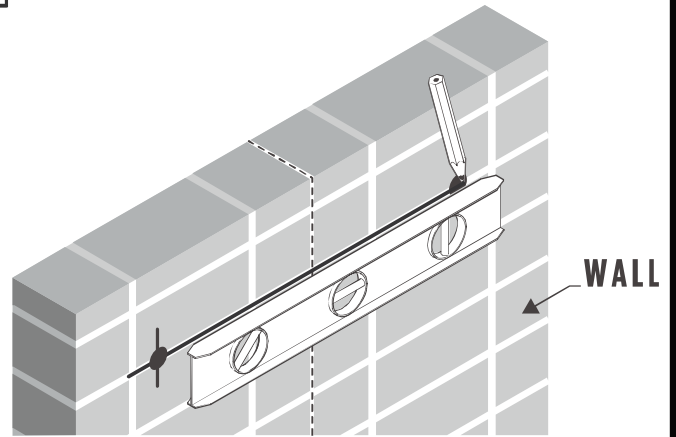

- 3** Once position is marked, drill 2 holes and insert anchors if stud is not available

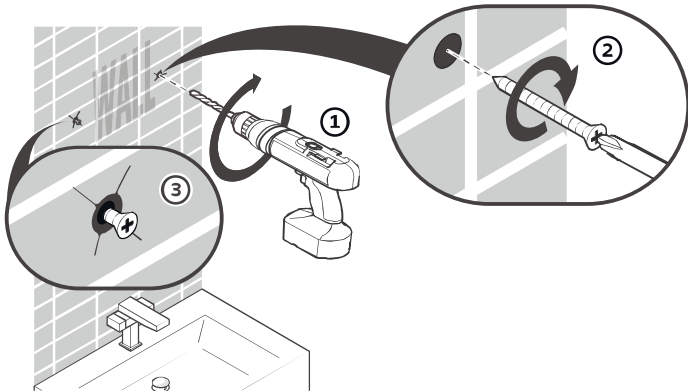

- 4** Hang mirror on the wall

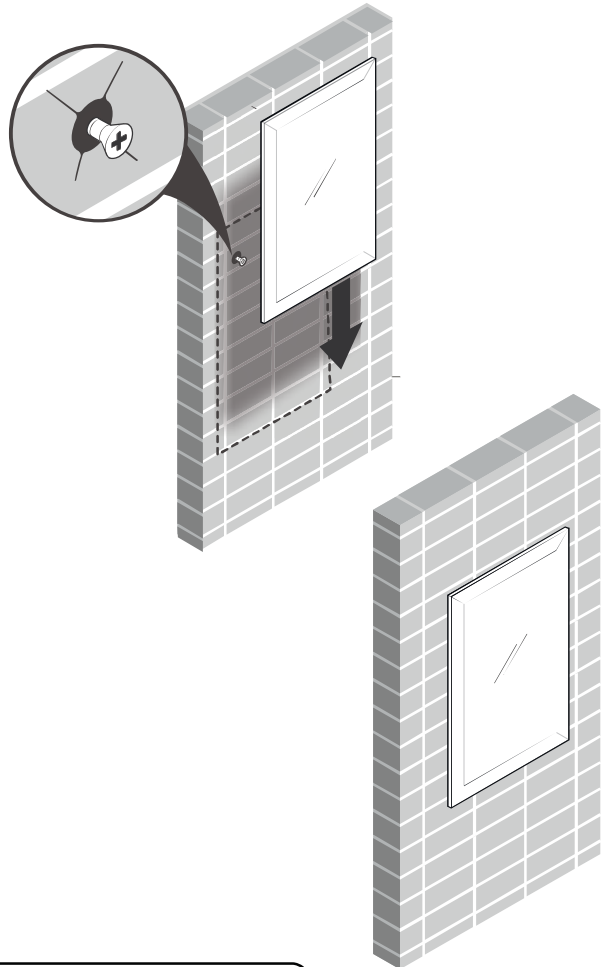

IMPORTANT:

CONSULT AN EXPERT FOR THE PROPER SCREWS/BOLTS TO USE WHEN ATTACHING TO VARIOUS WALL CONSTRUCTIONS. SCREWS PROVIDED **DO NOT ATTACH** TO ALL WALL CONSTRUCTION TYPES.

DRAWER REMOVAL

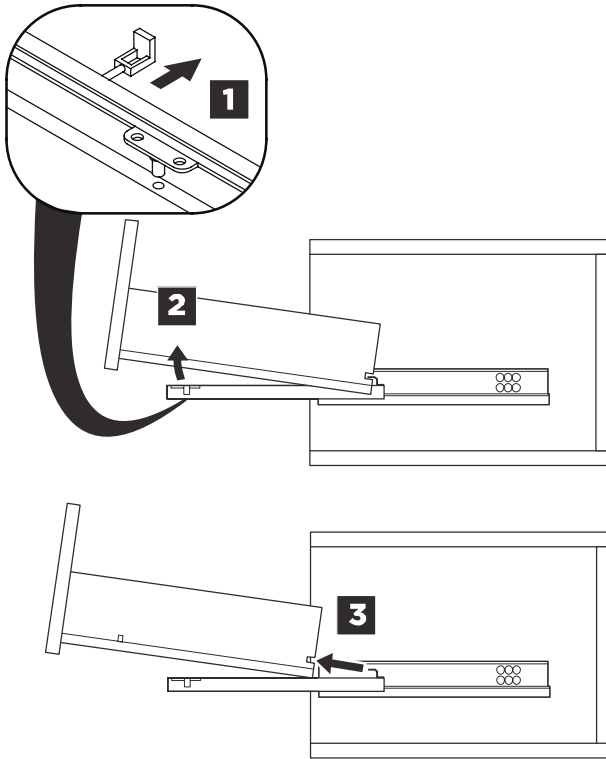

DRAWER INSTALLATION

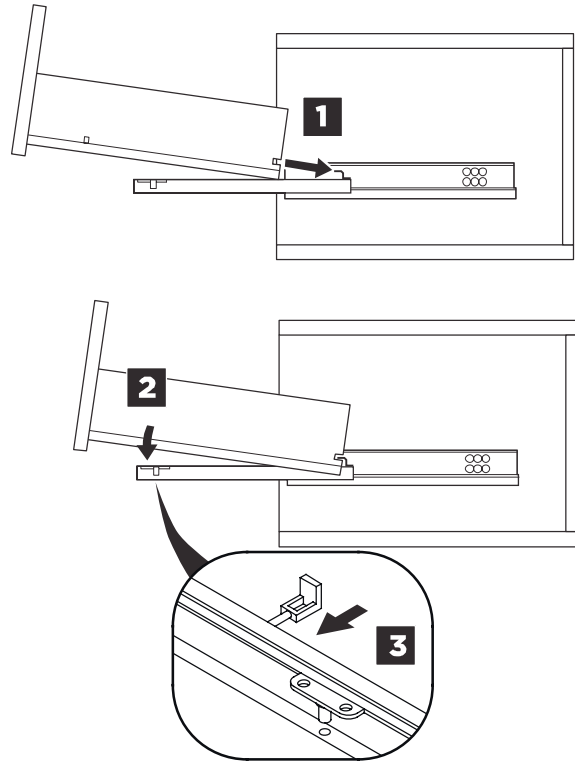

INSTALLATION INSTRUCTIONS

- 1** Secure cabinet to the wall

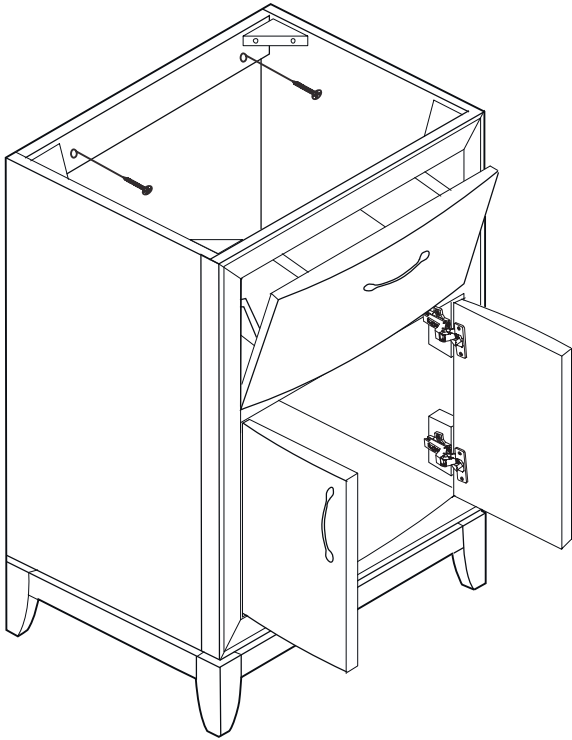

- 2** Apply a bead of silicone on the top of the cabinet and place the sink on top

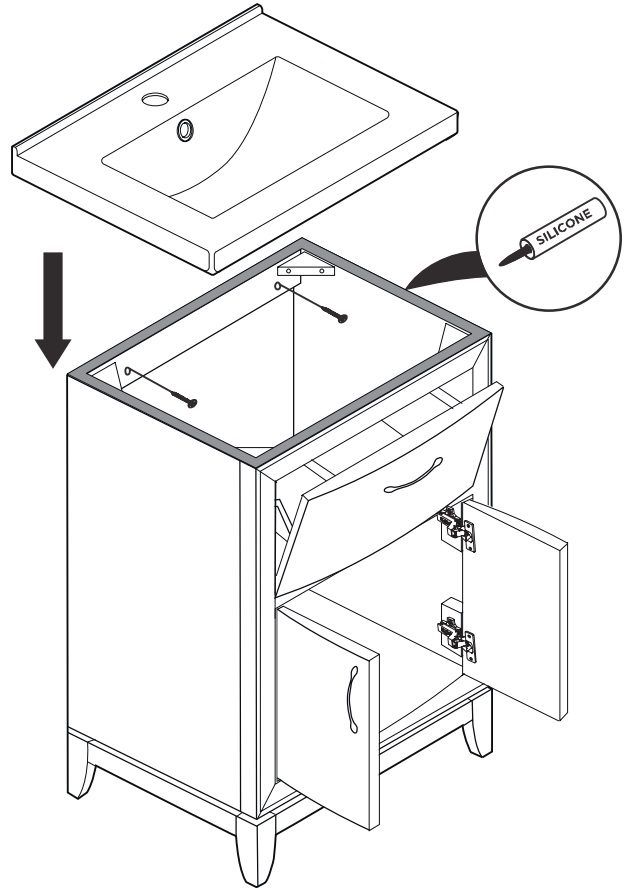

- 3** Remove side cabinet drawer
4 Secure cabinet to the wall

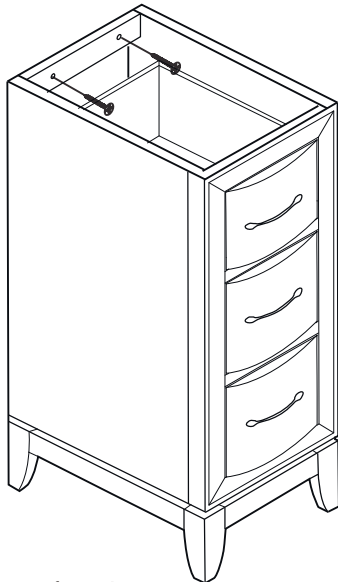

IMPORTANT:
Consult an expert for the proper screws/bolts to use when attaching to various wall constructions. Screws provided do not attach to all wall construction types.

- 5** Apply a bead of silicone on top of the cabinet and place the counter-top on top

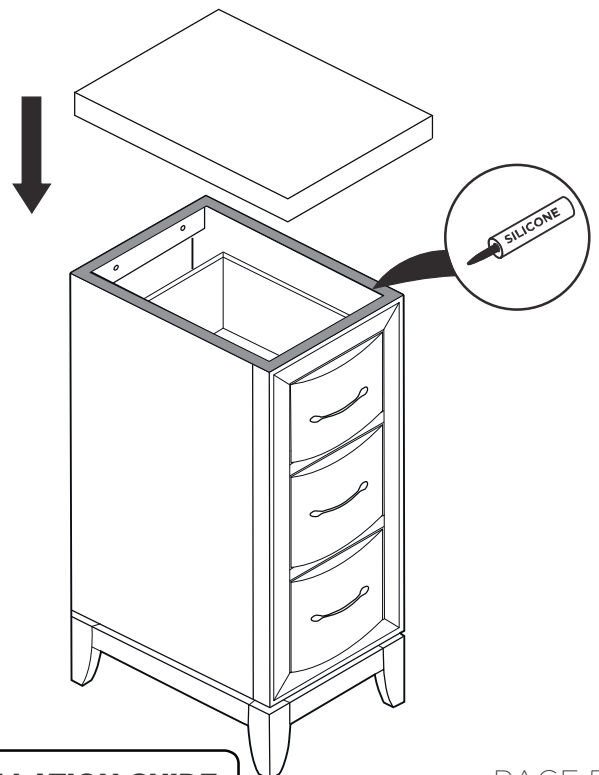

P-TRAP & POP-UP

INSTALLATION INSTRUCTIONS

Your item may appear slightly different from the illustration.

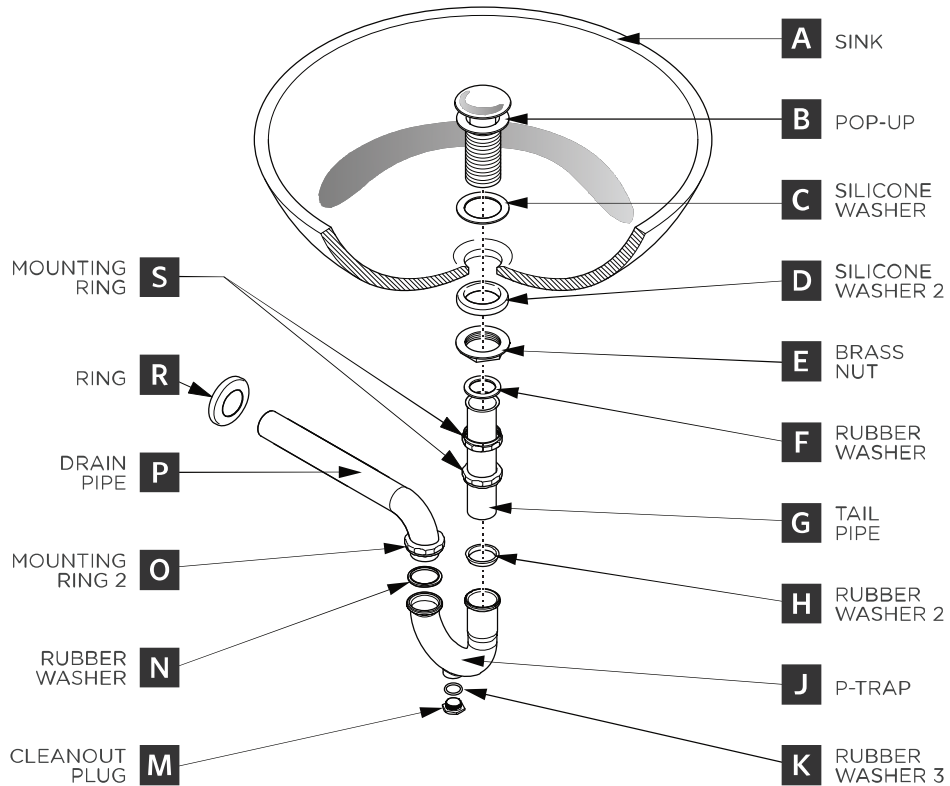

POP-UP INSTALLATION

FOR SINKS WITHOUT OVERFLOW

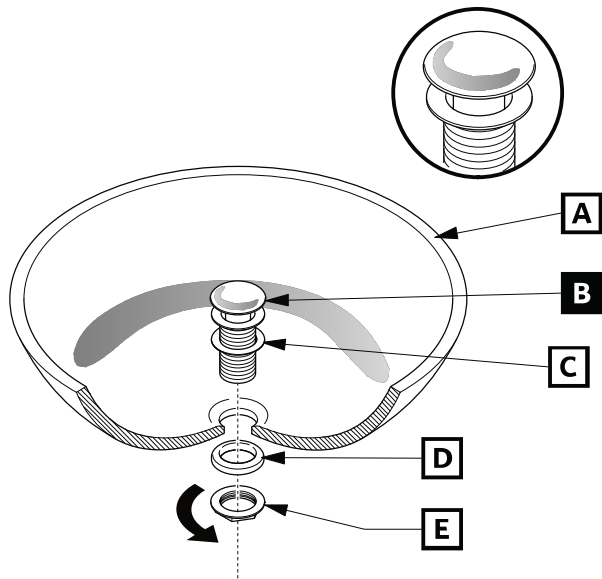

OR

FOR SINKS WITH OVERFLOW

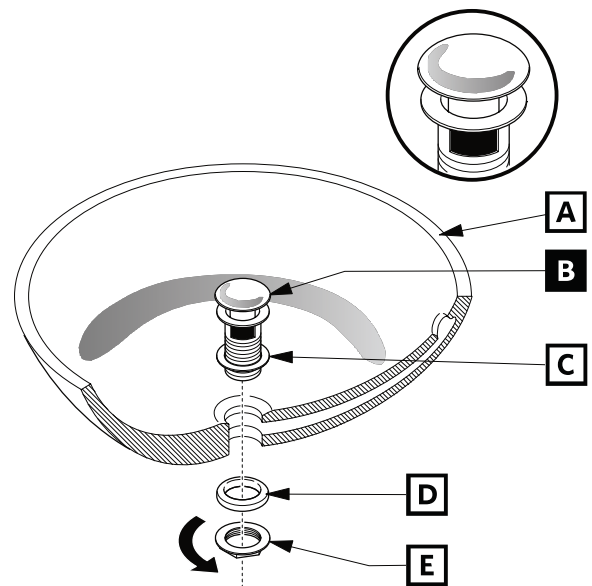

P-TRAP INSTALLATION

1 Install tail pipe (G)

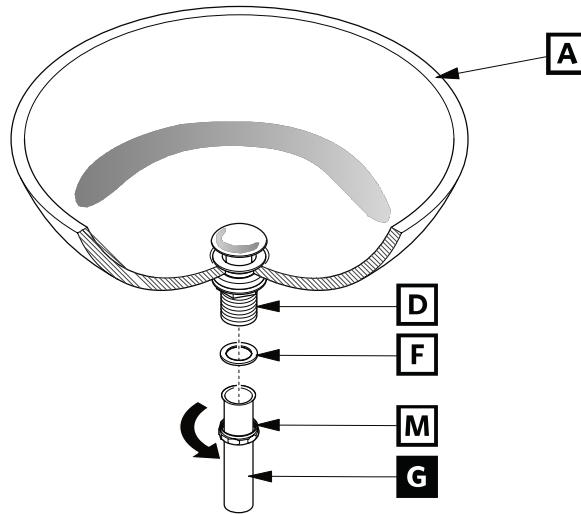

2 Install P-trap (J)

