

INSTALLATION INSTRUCTIONS

for Top Mount Pull-Out Waste Containers

For Models: 4WCTM-1550DM-1 and 4WCTM-2150DM-2



Step 1:

Install rear bracket to rear of slide.

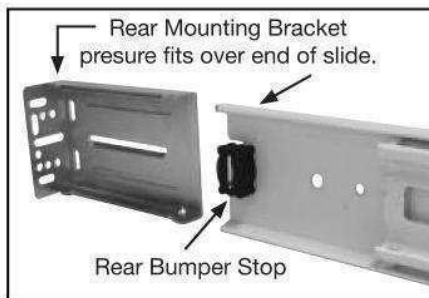

Step 2:

Install front of slide to face frame. Hole is placed $\frac{3}{8}$ " from front of cabinet. Bottom of slide should be 19" from cabinet floor. Use #8 x $\frac{5}{8}$ " Low Profile Truss Head Screw

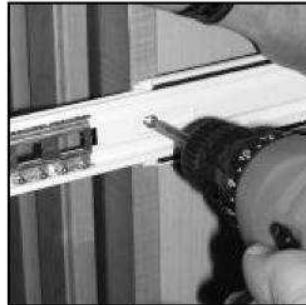

Step 3:

If rear of cabinet is thinner than $\frac{1}{2}$ ", install a $\frac{1}{2}$ " x 3" wide furring strip to the back of the cabinet centered $20\frac{1}{8}$ " from floor of cabinet.

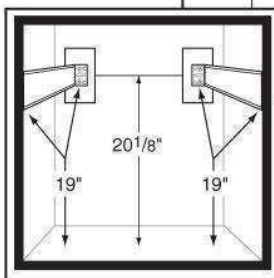
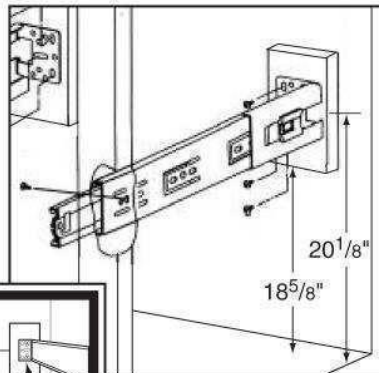

Step 4:

Measure from inside cabinet wall to inside face frame (A) distance should be measured the same at rear of cabinet (B).

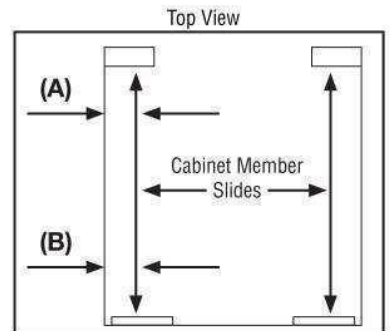

Step 5:

Mount Rear Bracket. Extend the slide rear mounting bracket until it contacts the rear (Furring Strip). Bottom of slide should be 19" from cabinet floor. Rear mounting bracket should be the same distance from the side cabinet wall at rear of slide as it is up front. Drive mounting screw in center horizontal slot of rear mounting bracket, tighten. Tighten screw in front bracket.

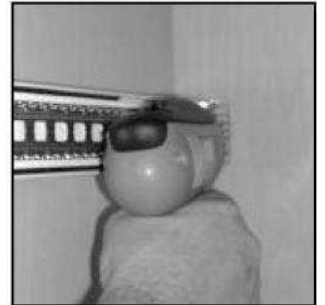

Step 6:

Install wood unit (with slides attached) into cabinet, engaging product member slides into cabinet member slides, push unit until it locks in place.

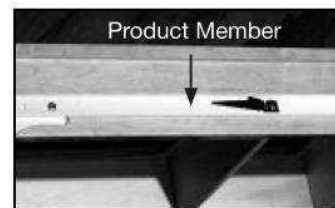

Step 7:

Mount Door...See separate instruction sheet included.