

Oval Wardrobe Rail Supports

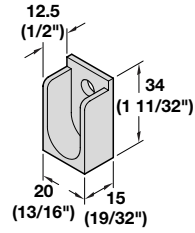
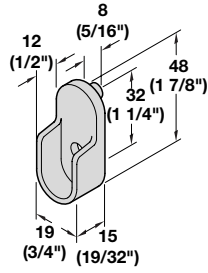
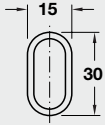

Wardrobe rail support, for insertion in Varianta 32 system holes, with 2 pins for Ø 5 mm holes and an additional screw hole
Finish: zinc die-cast

Color	Cat. No.
nickel-plated	803.33.722
chrome	803.33.210
brass-plated	803.33.520
white	803.33.830

Packing: 200 pcs.

Wardrobe rail support
for screw-mounting on side panel
Finish: plastic

Color	Cat. No.	Packing
natural	803.25.720	200 pcs.
chrome-plated	803.25.220	200 pcs.
black	803.25.328	10 pcs.

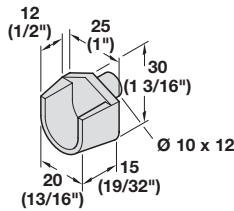
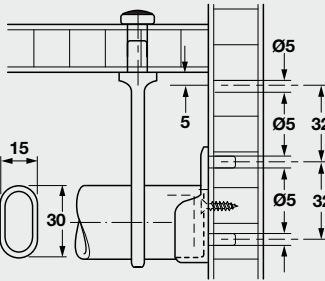
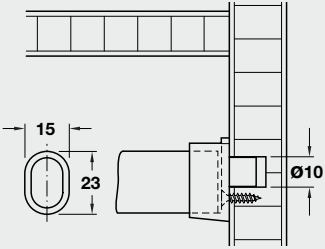

Wardrobe rail support, for Oval-Mini wardrobe rail with Ø 10 mm mounting pin and additional screw hole for mounting on the side panel
Finish: plastic, white

Cat. No.	803.22.747
----------	------------

Packing: 200 pcs.

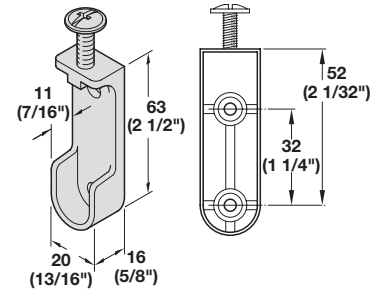

Wardrobe rail support, for screw-mounting under a shelf, with M6 x 28 mm mounting screw and 2 screw holes for panel fastening
Finish: zinc die-cast, nickel-plated

Cat. No.	803.32.720
----------	------------

Packing: 200 pcs. with mounting screws

Organizational Products for Kitchen, Bath, Closet and Home Entertainment

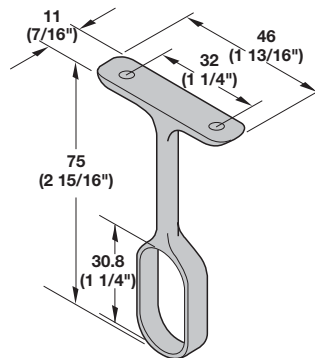

Oval Center Bracket, surface mount
for 15 x 30 mm rail
Finish: zinc die-cast

Cat. No.	chrome-plated	802.04.208
	brass-plated	802.04.500

Packing: 100 pcs.

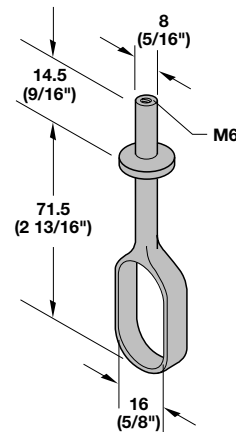

Oval Center Bracket, top mount
for 15 x 30 mm rail, mounts with M6 screw.
Finish: zinc die-cast

Cat. No.	chrome-plated	802.03.201
	brass-plated	802.03.809

Packing: 100 pcs. with mounting screw

Dimensional data not binding.
We reserve the right to alter
specifications without notice.