



Incredibly reliable. Unbelievably quiet.

Offering the CFM choices you need at the lowest sound levels in the industry.

FEATURES:

Grill:

- Conceals interior
- Low profile styling blends with any decor
- White polymeric

Blower:

- Low RPM for quiet operation
- Resilient anti-vibration mounts
- Dynamically-balanced, polymeric, centrifugal blower wheel for quiet, efficient performance
- Permanently lubricated, thermally protected motor
- Plug-in motor rated at 120 VAC
- Designed for continuous operation

Housing:

- Rugged, 20 gauge galvanized steel
- 6" round duct connector
- 1/2" acoustic insulation inside
- May be installed in ceiling or wall (size permitting)
- 8-position mounting brackets for easy installation and greater adaptability to various mounting requirements
- Automatic backdraft damper located within duct connector

TYPICAL SPECIFICATION:

Ventilator shall have galvanized steel housing insulated with at least 1/2" of acoustic insulation. Housing to have adjustable mounting brackets.

Automatic backdraft damper to be located within duct connector. Duct connector, blower assembly and wiring plate shall be adjustable for either horizontal or vertical installation.

Blower unit shall be removable from housing and will have a polymeric, dynamically balanced centrifugal-type blower wheel. Motor to be permanently lubricated and mounted with resilient anti-vibration mounts. RPM not to exceed number listed for each model.

Air delivery shall be no less and sound levels no greater than listed for each model. All air and sound ratings shall be certified by AMCA. Units to be cULus listed.



S&P USA Ventilation Systems, LLC, Div. of Soler & Palau Ventilation Group, certifies that the Losone Select Series shown herein are licensed to bear the AMCA Seal. The ratings shown are based on test and procedures performed in accordance with AMCA Publication 211 and AMCA Publication 311 and comply with the requirement of the AMCA Certified Ratings Program.



cULus listed for use over bathtubs and showers when connected to a GFCI protected branch circuit.

WEIGHT:

MODEL NO.	SHIPPING WEIGHT
L100	22.8 lbs.
L150	23.1 lbs.

DIMENSIONS:

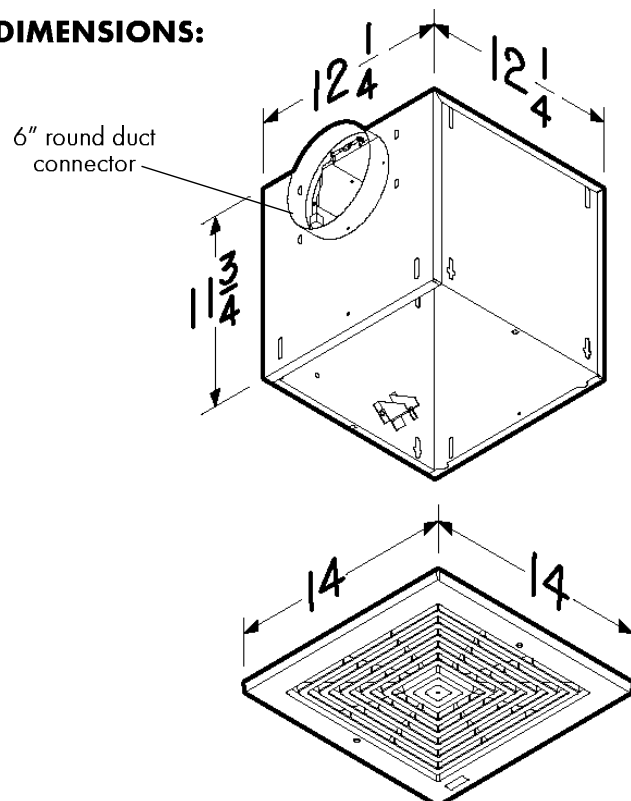



PERFORMANCE RATINGS:

AMCA LICENSED PERFORMANCE RATINGS

MODEL NO.	NOMINAL VOLTAGE	CFM/SONES - AT STATIC PRESSURES (Ps - inches of H ₂ O)											NOMINAL RPM	AMPS @ 60 Hz	WATTS
			0.0" Ps	.10" Ps	.125" Ps	.250" Ps	.375" Ps	.50" Ps	.625" Ps	.750" Ps	.875" Ps	1.0" Ps			
L100	120 VAC	CFM Hor.	136	115	109	93	80	65	44	-	-	-	640	1.1	87
		Sones Hor.	0.5	0.8	0.9	1.3	1.8	2.3	3.0	-	-	-			
		CFM Ver.	138	117	112	94	80	67	46	13	-	-	650	1.1	87
		Sones Ver.	0.7	0.9	1.0	1.3	1.8	2.2	2.8	3.0	-	-			
L150	120 VAC	CFM Hor.	181	161	157	141	132	124	114	94	62	-	710	1.3	100
		Sones Hor.	1.3	1.4	1.5	2.2	2.6	3.1	3.6	4.1	4.6	-			
		CFM Ver.	179	163	160	149	142	133	122	105	73	23	750	1.3	100
		Sones Ver.	1.4	1.6	1.6	2.0	2.5	3.0	3.3	3.6	3.9	4.2			

Performance ratings include the effects of inlet grill and backdraft damper in the airstream. Speed (RPM) shown is nominal. Performance is based on actual speed of test. The sound ratings shown are loudness values in fan sones at 5' (1.5m) in a hemispherical free field calculated per AMCA Std. 301. Values shown are for Installation Type B: free inlet fan sone levels. Performance shown is for Installation Type B: Free inlet, Ducted outlet.



S&P USA Ventilation Systems, LLC, Div. of Soler & Palau Ventilation Group, certifies that the Losone Select Series shown herein are licensed to bear the AMCA Seal. The ratings shown are based on test and procedures performed in accordance with AMCA Publication 211 and AMCA Publication 311 and comply with the requirement of the AMCA Certified Ratings Program.



cULus listed for use over bathtubs and showers when connected to a GFCI protected branch circuit.

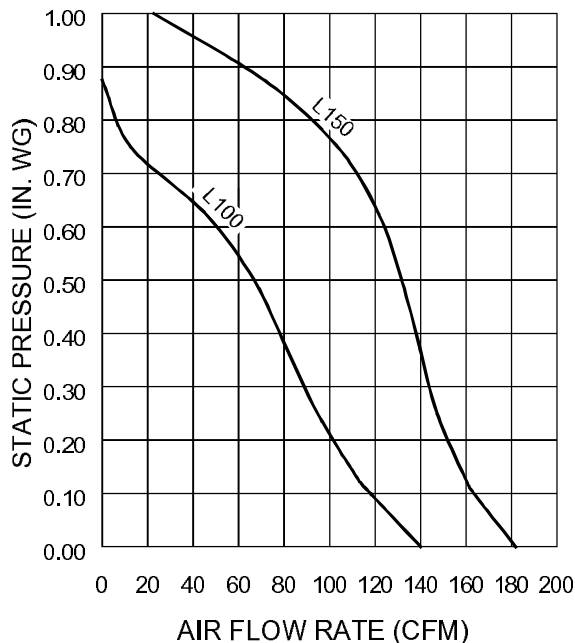

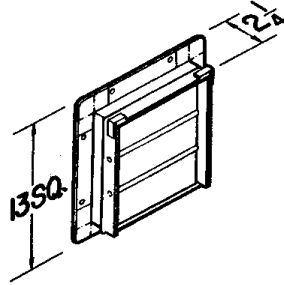

Model 441 Wall Cap

- Gravity dampers
- Collar with birdscreen for attaching 10" round duct
- Steel construction with aluminum louvers

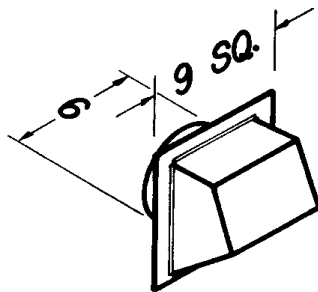

Model 641 Wall Cap

- Aluminum natural finish
- Built-in backdraft damper & birdscreen
- For 6" round duct

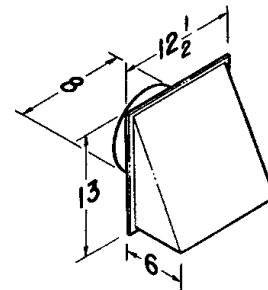

Model 643 Wall Cap

- Aluminum natural finish
- Built-in backdraft damper
- For 8" round duct

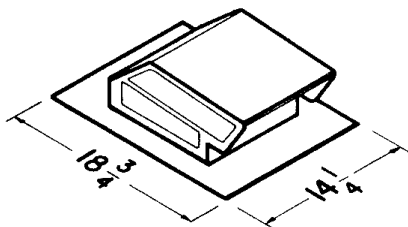

Model 634 Roof Cap

- Black electrically - bonded epoxy finish
- Built-in backdraft damper & birdscreen
- For 3 1/4" x 10" or up to 8" round duct

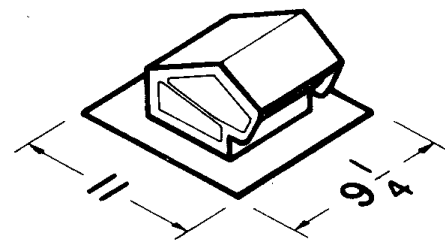

Model 636 Roof Cap

- Black electrically - bonded epoxy finish
- Built-in backdraft damper & birdscreen
- For 3" or 4" round duct

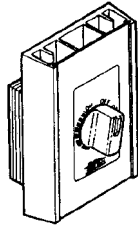

Speed Control

- Adjust speed from 100 to 50%
- 5 amp & 10 amp - 120V

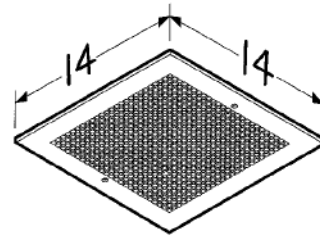

Model MG 1 Metal Grille Kit

- White enamel painted steel
- Mounting screws included
- Fits L100, L150, L200, L250 & L300

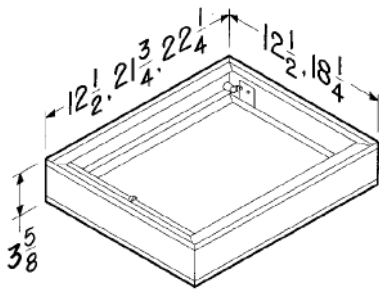

Models RD1, RD2 & RD3 Radiation Dampers

- UL rated for use in 1, 2 or 3 hour rated floor-ceiling, roof-ceiling design
- Galvanized steel frame
- High temperature, non-asbestos, reinforced fiberthermal fabric
- 212 °F fusible link
- Stainless steel negator-type closure spring
- RD1 (12 1/2" X 12 1/2") fits L100 - L300
- RD2 (21 3/4" X 12 1/2") fits L400 - L700
- RD3 (22.25" X 18.25") fits L900 - L1500

OPTIONAL ACCESSORY COMPATIBILITY CHART		LOSONE SELECT CEILING MOUNT						LOSONE SELECT IN-LINE/CABINET					
		L100 L150	L200 L250 L300	L400 L500	L700	L900	L1500	L100L L150L	L200L L250L L300L	L400L L500L L700L	L900L	L1500L	L2000L
VARIABLE SPEED CONTROLS	2727.1 (5 AMP 120V) ●	X	X	X			X	X					
	2828.1 (10AMP 120V) ●	X	X	X	X	X	X	X	X	X	X	X	X
Roof Caps	634 ●	X	X					X	X				
	636 ●												
WALL CAPS	441 ◆			X	X					X			
	641 ●	X						X					
	643 ●		X						X				
UL RADIATION DAMPERS	RD1 ◆	X	X										
	RD2 ◆			X	X								
	RD3 ◆					X	X						
METAL GRILLE KIT	MG1 ●	X	X										
VIBRATION DAMPENING HANGERS (4)	V102 ●	X	X	X	X	X		X	X	X	X		
	V104KIT ●	X	X	X	X	X	X	X	X	X	X	X	X



Incredibly reliable. Unbelievably quiet.
Offering the CFM choices you need at the lowest sound levels in the industry.

FEATURES:

Grill:

- Conceals interior
- Low profile styling blends with any decor
- White polymeric

Blower:

- Low RPM for quiet operation
- Resilient anti-vibration mounts
- Dynamically-balanced, polymeric, centrifugal blower wheel for quiet, efficient performance
- Permanently lubricated, thermally protected motor
- Plug-in motor rated at 120 VAC
- Designed for continuous operation

Housing:

- Rugged, 20 gauge galvanized steel
- 8" round duct connector
- 1/2" acoustic insulation inside
- May be installed in ceiling or wall (size permitting)
- 8-position mounting brackets for easy installation and greater adaptability to various mounting requirements
- Automatic backdraft damper located within duct connector
- Factory-shipped in horizontal discharge position - easily converted to vertical discharge

TYPICAL SPECIFICATION:

Ventilator shall have galvanized steel housing insulated with at least 1/2" of acoustic insulation. Housing to have adjustable mounting brackets.

Automatic backdraft damper to be located within duct connector. Duct connector, blower assembly and wiring plate shall be adjustable for either horizontal or vertical installation.

Blower unit shall be removable from housing and will have a polymeric, dynamically balanced centrifugal-type blower wheel. Motor to be permanently lubricated and mounted with resilient anti-vibration mounts. RPM not to exceed number listed for each model.

Air delivery shall be no less and sound levels no greater than listed for each model. All air and sound ratings shall be certified by AMCA. Units to be cULus listed.



S&P USA Ventilation Systems, LLC, Div. of Soler & Palau Ventilation Group, certifies that the Losone Select Series shown herein are licensed to bear the AMCA Seal. The ratings shown are based on test and procedures performed in accordance with AMCA Publication 211 and AMCA Publication 311 and comply with the requirement of the AMCA Certified Ratings Program.



cULus listed for use over bathtubs and showers when connected to a GFCI protected branch circuit.

WEIGHT:

MODEL NO.	SHIPPING WEIGHT
L200	23.0 lbs.
L250	23.1 lbs.
L300	23.1 lbs.

DIMENSIONS:

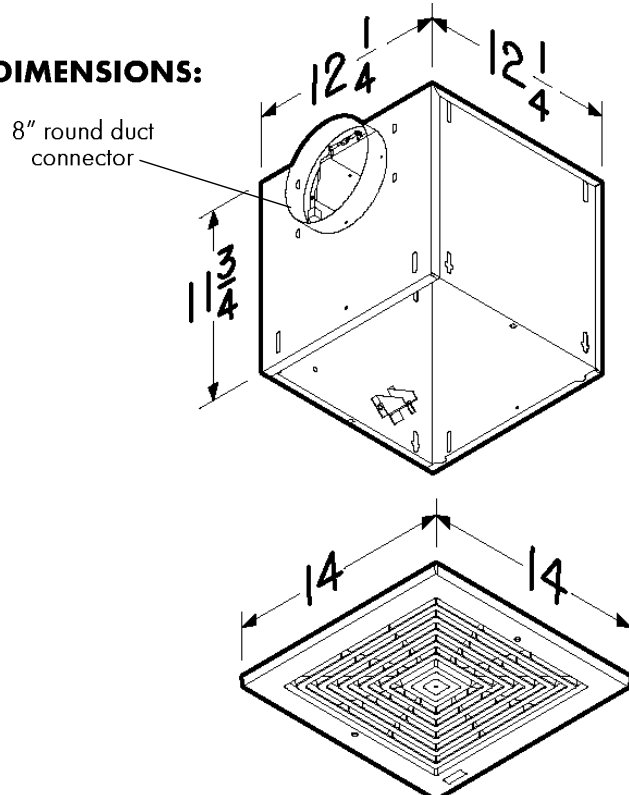



PERFORMANCE RATINGS:

AMCA LICENSED PERFORMANCE RATINGS

MODEL NO.	NOMINAL VOLTAGE	CFM/SONES - AT STATIC PRESSURES (Ps - inches of H ₂ O)											NOMINAL RPM	AMPS @ 60 Hz	WATTS
		0.0" Ps	.10" Ps	.125" Ps	.250" Ps	.375" Ps	.50" Ps	.625" Ps	.750" Ps	.875" Ps	1.0" Ps				
L200	120 VAC	CFM Hor.	231	214	210	196	186	177	165	144	113	51	740	1.8	127
		Sones Hor.	1.6	1.8	1.7	2.3	2.9	3.5	4.1	4.9	5.3	5.3			
		CFM Ver.	224	210	207	197	187	179	167	144	99	41	760	1.8	127
		Sones Ver.	1.5	1.8	2.0	2.3	2.7	3.4	4.0	4.5	5.1	5.2			
L250	120 VAC	CFM Hor.	272	261	259	250	242	233	218	201	165	99	830	2.1	166
		Sones Hor.	2.1	2.3	2.2	2.9	3.3	3.9	4.4	4.8	5.5	5.8			
		CFM Ver.	269	261	259	253	248	239	224	203	171	101	860	2.1	166
		Sones Ver.	2.3	2.6	2.7	3.0	3.3	3.7	4.2	4.7	5.4	5.6			
L300	120 VAC	CFM Hor.	312	309	308	303	296	287	273	254	219	125	905	2.6	212
		Sones Hor.	2.8	2.9	2.9	3.3	3.5	3.9	4.3	4.7	5.1	5.6			
		CFM Ver.	319	314	313	306	299	288	274	251	219	120	940	2.6	212
		Sones Ver.	2.6	2.9	3.0	3.4	3.6	3.9	4.4	4.7	5.0	5.5			

Performance ratings include the effects of inlet grill and backdraft damper in the airstream. Speed (RPM) shown is nominal. Performance is based on actual speed of test. The sound ratings shown are loudness values in fan sones at 5' (1.5m) in a hemispherical free field calculated per AMCA Std. 301. Values shown are for Installation Type B: free inlet fan sone levels. Performance shown is for Installation Type B: Free inlet, Ducted outlet.

AMCA WORLDWIDE CERTIFIED RATINGS
SOUND AND AIR PERFORMANCE
 S&P USA Ventilation Systems, LLC., Div. of Soler & Palau Ventilation Group, certifies that the Losone Select Series shown herein are licensed to bear the AMCA Seal. The ratings shown are based on test and procedures performed in accordance with AMCA Publication 211 and AMCA Publication 311 and comply with the requirement of the AMCA Certified Ratings Program.

UL LISTED
 cULus listed for use over bathtubs and showers when connected to a GFCI protected branch circuit.

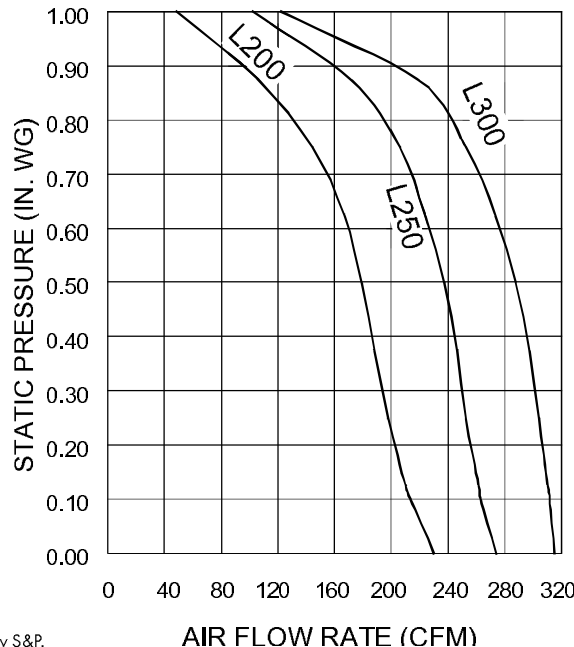

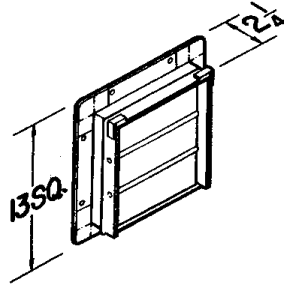

Model 441 Wall Cap

- Gravity dampers
- Collar with birdscreen for attaching 10" round duct
- Steel construction with aluminum louvers

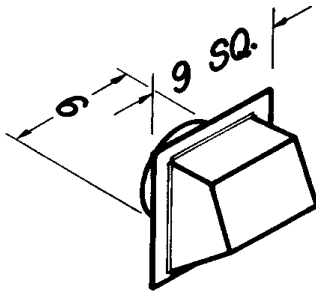

Model 641 Wall Cap

- Aluminum natural finish
- Built-in backdraft damper & birdscreen
- For 6" round duct

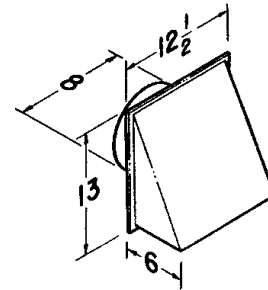

Model 643 Wall Cap

- Aluminum natural finish
- Built-in backdraft damper
- For 8" round duct

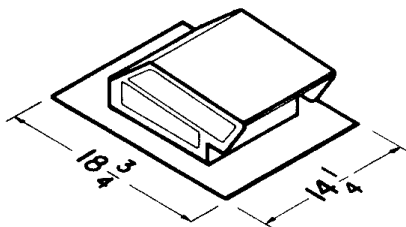

Model 634 Roof Cap

- Black electrically - bonded epoxy finish
- Built-in backdraft damper & birdscreen
- For 3 1/4" x 10" or up to 8" round duct

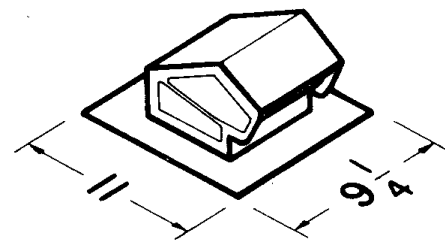

Model 636 Roof Cap

- Black electrically - bonded epoxy finish
- Built-in backdraft damper & birdscreen
- For 3" or 4" round duct

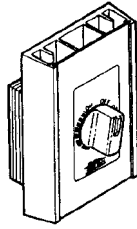

Speed Control

- Adjust speed from 100 to 50%
- 5 amp & 10 amp - 120V

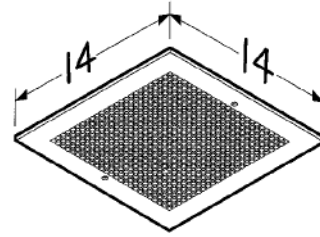

Model MG 1 Metal Grille Kit

- White enamel painted steel
- Mounting screws included
- Fits L100, L150, L200, L250 & L300

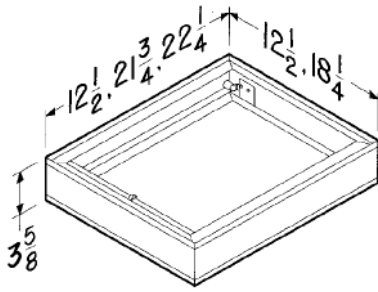

Models RD1, RD2 & RD3 Radiation Dampers

- UL rated for use in 1, 2 or 3 hour rated floor-ceiling, roof-ceiling design
- Galvanized steel frame
- High temperature, non-asbestos, reinforced fiberthermal fabric
- 212 °F fusible link
- Stainless steel negator-type closure spring
- RD1 (12 1/2" X 12 1/2") fits L100 - L300
- RD2 (21 3/4" X 12 1/2") fits L400 - L700
- RD3 (22.25" X 18.25") fits L900 - L1500

OPTIONAL ACCESSORY COMPATIBILITY CHART		LOSONE SELECT CEILING MOUNT						LOSONE SELECT IN-LINE/CABINET					
		L100 L150	L200 L250 L300	L400 L500	L700	L900	L1500	L100L L150L	L200L L250L L300L	L400L L500L L700L	L900L	L1500L	L2000L
VARIABLE SPEED CONTROLS	2727.1 (5 AMP 120V) ●	X	X	X			X	X					
	2828.1 (10AMP 120V) ●	X	X	X	X	X	X	X	X	X	X	X	X
Roof Caps	634 ●	X	X					X	X				
	636 ●												
WALL CAPS	441 ◆			X	X					X			
	641 ●	X						X					
	643 ●		X						X				
UL RADIATION DAMPERS	RD1 ◆	X	X										
	RD2 ◆			X	X								
	RD3 ◆					X	X						
METAL GRILLE KIT	MG1 ●	X	X										
VIBRATION DAMPENING HANGERS (4)	V102 ●	X	X	X	X	X		X	X	X	X		
	V104KIT ●	X	X	X	X	X	X	X	X	X	X	X	X