



Incredibly reliable. Unbelievably quiet.
Offering the CFM choices you need at the lowest sound levels in the industry.

FEATURES:

Blower:

- Low RPM for quiet operation
- Resilient anti-vibration mounts
- Dynamically-balanced, polymeric, centrifugal blower wheel for quiet, efficient performance
- Permanently lubricated, thermally protected motor
- Plug-in motor rated at 120 VAC
- Designed for continuous operation

Housing:

- Rugged, galvanized steel
- 4½" x 18½" duct connectors
- May be installed in ceiling or wall (size permitting)
- 8-position mounting brackets for easy installation and greater adaptability to various mounting requirements
- Automatic backdraft damper located within duct connector
- Factory-shipped in horizontal discharge position
- Removable panel allows easy access to the motor without disturbing ductwork

TYPICAL SPECIFICATION:

Ventilator shall have galvanized steel housing. Housing to have adjustable mounting brackets and removable panel to allow access to motor without disturbing ductwork.

Automatic backdraft damper to be located within duct connector. Duct connector, blower assembly and wiring plate shall be adjustable for either horizontal or vertical installation.

Blower unit shall be removable from housing and will have a polymeric, dynamically balanced centrifugal-type blower wheel. Motor to be permanently lubricated and mounted with resilient anti-vibration mounts. RPM not to exceed number listed for each model.

Air delivery shall be no less and sound levels no greater than listed for each model. All air and sound ratings shall be certified by AMCA. Units to be cULus listed.

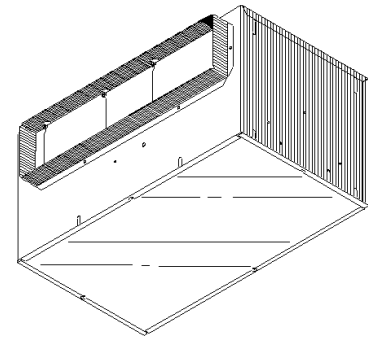

S&P USA Ventilation Systems, LLC, Div. of Soler & Palau Ventilation Group, certifies that the Losone Select Series shown herein are licensed to bear the AMCA Seal. The ratings shown are based on test and procedures performed in accordance with AMCA Publication 211 and AMCA Publication 311 and comply with the requirement of the AMCA Certified Ratings Program.



WEIGHT:

MODEL NO.	SHIPPING WEIGHT
L400L	33.9 lbs.
L500L	33.9 lbs.
L700L	34.0 lbs.

DIMENSIONS:

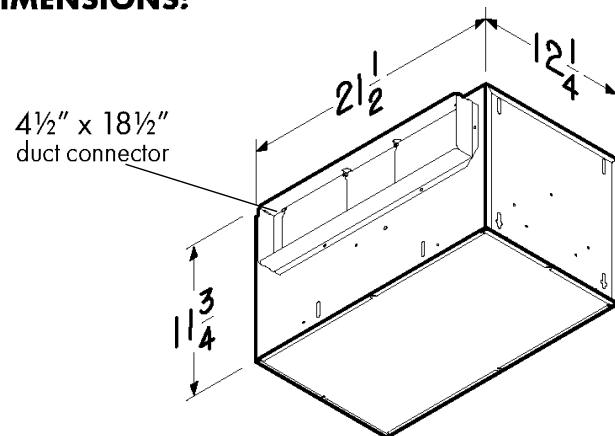

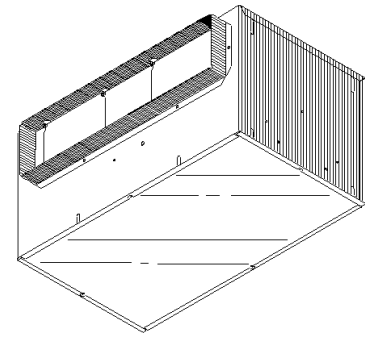

PERFORMANCE RATINGS:

AMCA LICENSED PERFORMANCE RATINGS

MODEL NO.	NOMINAL VOLTAGE	CFM/SONES - AT STATIC PRESSURES (Ps - inches of H ₂ O)											NOMINAL RPM	AMPS @ 60 Hz	WATTS
			0.0" Ps	.10" Ps	.125" Ps	.250" Ps	.375" Ps	.50" Ps	.625" Ps	.750" Ps	.875" Ps	1.0" Ps			
L400L	120 VAC	CFM St. Thr.	450	415	406	360	313	271	223	167	90	6	775	1.4	146
		Sones St. Thr.	1.4	1.6	1.6	1.9	2.2	2.6	2.9	3.4	3.6	3.9			
		CFM Rt. Ang.	442	415	408	372	336	296	239	193	111	28	875	1.4	146
		Sones Rt. Ang.	1.6	1.7	1.7	2.0	2.4	2.6	3.1	3.4	3.9	4.1			
L500L	120 VAC	CFM St. Thr.	546	526	519	496	472	447	407	364	306	232	890	2.2	232
		Sones St. Thr.	2.4	2.4	3.4	3.7	3.9	3.8	3.9	4.0	4.3	4.3			
		CFM Rt. Ang.	528	516	513	494	470	446	415	389	334	247	990	2.2	232
		Sones Rt. Ang.	2.9	3.8	3.4	3.7	3.5	3.6	3.9	4.0	4.2	4.4			
L700L	120 VAC	CFM St. Thr.	704	686	681	656	631	604	575	533	480	412	1090	2.9	313
		Sones St. Thr.	3.6	3.8	3.7	3.9	4.0	4.2	4.3	4.4	4.7	5.0			
		CFM Rt. Ang.	680	667	663	644	621	594	557	513	440	342	1205	2.9	313
		Sones Rt. Ang.	5.0	5.0	5.0	5.3	5.2	5.1	5.3	5.5	5.4	5.5			

Performance ratings include the effects of backdraft damper in the airstream. Speed (RPM) shown is nominal. Performance is based on actual speed of test. The sound ratings shown are loudness values in fan sones at 5' (1.5m) in a hemispherical free field calculated per AMCA Std. 301. Values shown are for Installation Type D: Ducted inlet, Ducted outlet. Ratings do not include the effect of duct end correction. Performance ratings include the effects of 18 feet of round inlet duct and, if needed, a rectangular to round duct transition in the airstream. Performance shown is for Installation Type D: Ducted inlet, Ducted outlet.



S&P USA Ventilation Systems, LLC, Div. of Soler & Palau Ventilation Group, certifies that the Losone Select Series shown herein are licensed to bear the AMCA Seal. The ratings shown are based on test and procedures performed in accordance with AMCA Publication 211 and AMCA Publication 311 and comply with the requirement of the AMCA Certified Ratings Program.

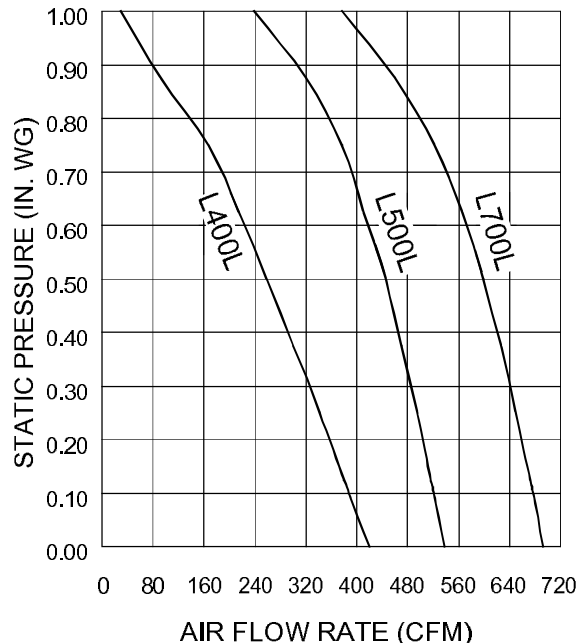

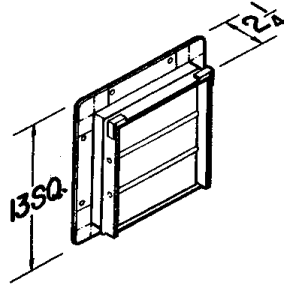

Model 441 Wall Cap

- Gravity dampers
- Collar with birdscreen for attaching 10" round duct
- Steel construction with aluminum louvers

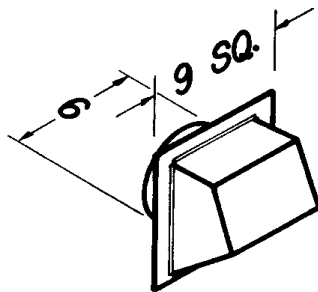

Model 641 Wall Cap

- Aluminum natural finish
- Built-in backdraft damper & birdscreen
- For 6" round duct

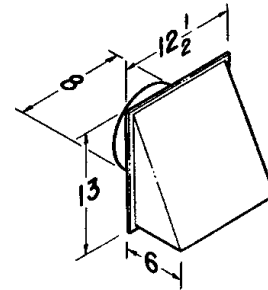

Model 643 Wall Cap

- Aluminum natural finish
- Built-in backdraft damper
- For 8" round duct

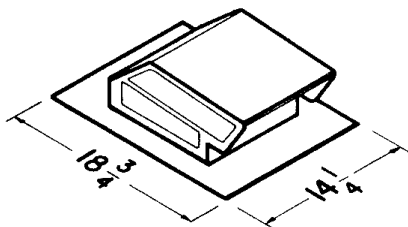

Model 634 Roof Cap

- Black electrically - bonded epoxy finish
- Built-in backdraft damper & birdscreen
- For 3 1/4" x 10" or up to 8" round duct

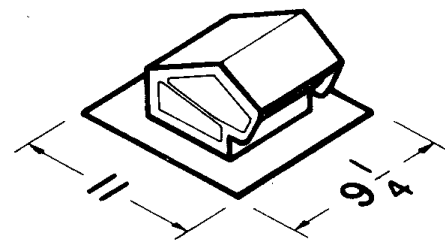

Model 636 Roof Cap

- Black electrically - bonded epoxy finish
- Built-in backdraft damper & birdscreen
- For 3" or 4" round duct

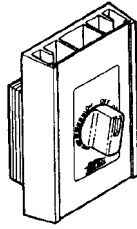

Speed Control

- Adjust speed from 100 to 50%
- 5 amp & 10 amp - 120V

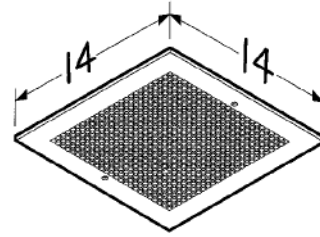

Model MG 1 Metal Grille Kit

- White enamel painted steel
- Mounting screws included
- Fits L100, L150, L200, L250 & L300

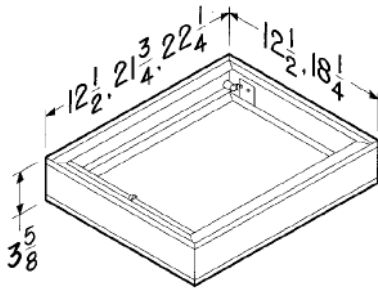

Models RD1, RD2 & RD3 Radiation Dampers

- UL rated for use in 1, 2 or 3 hour rated floor-ceiling, roof-ceiling design
- Galvanized steel frame
- High temperature, non-asbestos, reinforced fiberthermal fabric
- 212 °F fusible link
- Stainless steel negator-type closure spring
- RD1 (12 1/2" X 12 1/2") fits L100 - L300
- RD2 (21 3/4" X 12 1/2") fits L400 - L700
- RD3 (22.25" X 18.25") fits L900 - L1500

OPTIONAL ACCESSORY COMPATIBILITY CHART		LOSONE SELECT CEILING MOUNT						LOSONE SELECT IN-LINE/CABINET					
		L100 L150	L200 L250 L300	L400 L500	L700	L900	L1500	L100L L150L	L200L L250L L300L	L400L L500L L700L	L900L	L1500L	L2000L
VARIABLE SPEED CONTROLS	2727.1 (5 AMP 120V) ●	X	X	X			X	X					
	2828.1 (10AMP 120V) ●	X	X	X	X	X	X	X	X	X	X	X	X
Roof Caps	634 ●	X	X					X	X				
	636 ●												
WALL CAPS	441 ◆			X	X					X			
	641 ●	X						X					
	643 ●		X						X				
UL RADIATION DAMPERS	RD1 ◆	X	X										
	RD2 ◆			X	X								
	RD3 ◆					X	X						
METAL GRILLE KIT	MG1 ●	X	X										
VIBRATION DAMPENING HANGERS (4)	V102 ●	X	X	X	X	X		X	X	X	X		
	V104KIT ●	X	X	X	X	X	X	X	X	X	X	X	X