

Shower Drain Installation Instructions

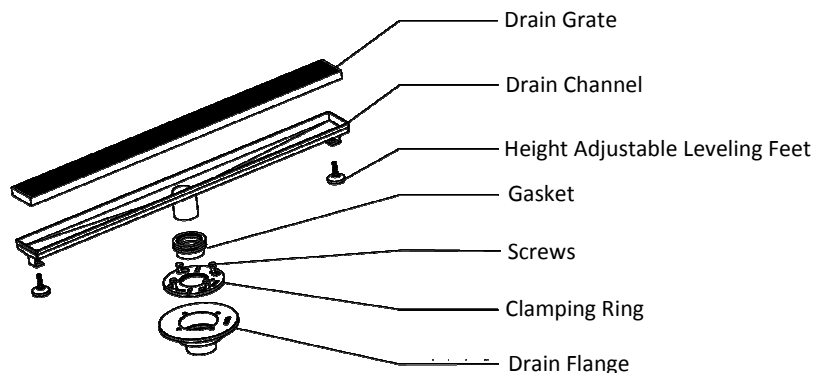
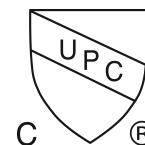

*Drawings are for reference only. Please refer to actual product for exact size, shape and parts.

PREPARATION

- **Before Installation**
Before installing any Dawn product in your new or remodeled kitchen, you should make sure that you are in compliance with all local plumbing codes.
- **Check The Accessory Items**
Before installation, please check the condition of the product and, if appropriate, its components. If there is any problem with the product and/or its components, please contact the store you purchased it from for a replacement. As soon as you have inspected your product, please return it to its original packaging until you are ready to install it.
- **Handle With Care**
To protect its finish and avoid damage before and after installation, please handle the product with care. For care and cleaning tips after installation, please refer to the *Care and Cleaning Guide* in this instruction guide.

MATERIALS & TOOLS

Safety glasses, assorted screwdrivers, silicone sealant, flooring mortar, and other tools as needed

INSTALLATION

IMPORTANT: Recommended for professional installers only. The installer maintains responsibility for installing the product safely.

1. Determine the desired position of the shower drain.
Relocate rough-in pipework if necessary. Cover with flooring mortar as needed.

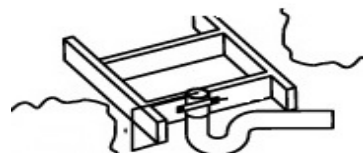

2. Assemble the drain grate to the drain channel.

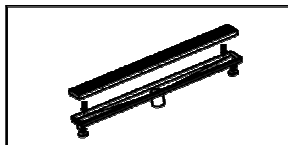

3. Assemble the clamping ring to the drain flange, and then install the gasket into the drain flange. Fasten the assembly with the screws.

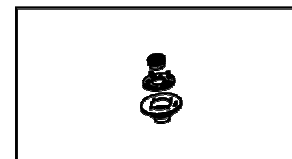

4. Insert the drain channel into the gasket.
Push the drain channel down to ensure the correct height.

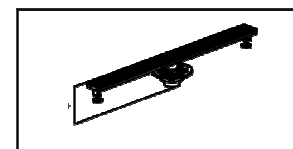
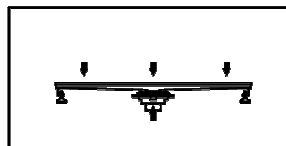

5. Install the drain flange to the rough-in pipe.
Run water through the drain and check for leaks.

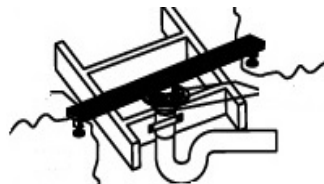

6. Adjust the leveling feet to level and stabilize the shower drain unit.
The top of the drain channel should be flush with the surface of the finished floor.

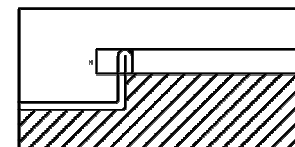
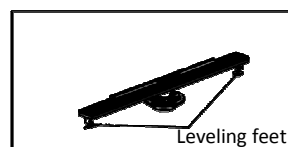

7. Apply a bead of silicone sealant around the outside of the shower drain.
Complete the installation by installing the preferred flooring.

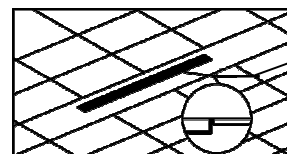

Silicone sealant

CARE AND CLEANING GUIDE

Dawn stainless steel shower drains are designed to minimize cleaning and maintenance. High-pressure flushing is the most effective method of cleaning, and, if performed regularly, will keep the drains clean in most situations. Only use a mild soap and a soft cloth for cleaning. **DO NOT** use any abrasive cleaners or scrub pads. **DO NOT** allow household cleaning agents, such as bleach, sit on your drain cover for a long period of time. In cases where a stainless steel cleaner is necessary, rinse the drains with plenty of water after use.

WARRANTY INFORMATION

One-Year Limited Warranty

Dawn® ceramic sinks, sink accessories, vanities, plumbing products and kitchen/bath accessories are warranted to be free of defects in material and workmanship for one year from date of purchase. Dawn® will, at its own election, repair, replace or make appropriate adjustment where Dawn® inspection discloses any such defects occurring in normal usage within one (1) year after purchase. Dawn® is not responsible for removal or installation costs. This warranty voids if the product has been moved from its original installation location. Defective parts or products will be replaced on availability basis. Dawn® warranty does not apply to any local building codes. It is the customer's responsibility to comply with all local plumbing codes before installation.

Note: Dawn® vanities are made from natural raw materials. Grain and color differences among wood, plant species, stone, and minerals occur naturally and are not considered a defect. All wood darkens with age, which is considered a natural feature and not a defect. If a replacement part is needed, exact color or grain match cannot be guaranteed. Exposure to direct sunlight may cause color variation and/or surface damage and will not be covered under warranty. Tempered glass may have a green tint which is a result of the tempering process and is not considered a defect. Color variation in stone is also a natural occurrence, and therefore new or replacement pieces may not match store display samples.

DAWN® WARRANTIES DO NOT COVER, AND DAWN® DISCLAIMS ANY LIABILITY FOR:

1. Conditions or damage NOT resulting from defects in material or workmanship.
2. Conditions or damage resulting from:
 - Normal wear and tear, improper installation or maintenance, misuse, abuse, negligence, accident, moving (tipping) or alteration, scratches or handling damages.
 - Use of abrasive cleaning products or the use of the product in any manner contrary to the product instructions.
 - Conditions in the home such as excessive water pressure, water quality or corrosion.
3. Labor, shipping or other costs for removal, installation, replacement or return of product for warranty service.
4. Parts, accessories, connected materials or related products that are not manufactured by Dawn®.
5. Imperfections such as checks (small surface splits), pitch pockets (small dark holes), grain or darker mineral streaks are natural and are not considered defects.
6. An invoice number will be required for proof of purchase

Dawn® reserves the right to inspect any Dawn® product reported to be defective prior to any repair or replacement. Repair and replacement costs EXCLUDE shipping, labor, and consequential expenses.

LEGAL DISCLAIMER:

- This instruction guide is done as a public service to customers of Dawn Kitchen & Bath Products, Inc. ("Dawn"). For special situations or further assistance, please consult professionals.
- All products should be inspected by customers upon receipt and before any installation. Any defective product should be reported immediately and should NOT be installed.
- Requirements may vary for installation in a concrete or wooden floor/subfloor.
- Dawn reserves the right to make revisions in any product design without notice for improvement of product performance and quality.
- Installation by professional installers is highly recommended. Dawn assumes no liability for any damages incurred through the use of information provided in this guide.