

FVN9430
SENZA
INSTALLATION GUIDE

kitchensource.com
1.800.667.8721

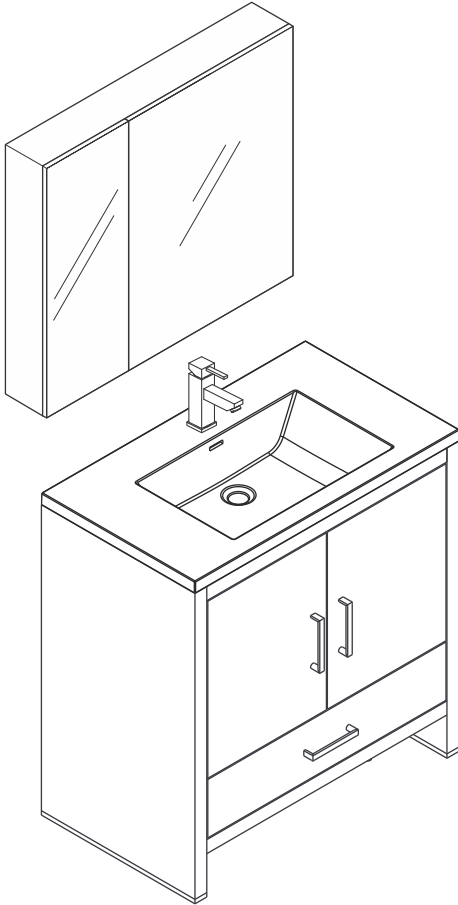

FVN9430
Vanity Front



FMC8090
Medicine Cabinet Front

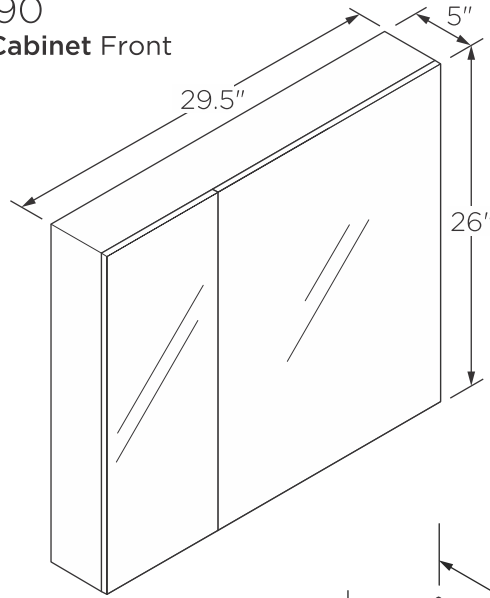

FVS9330WH
Counter Top Front

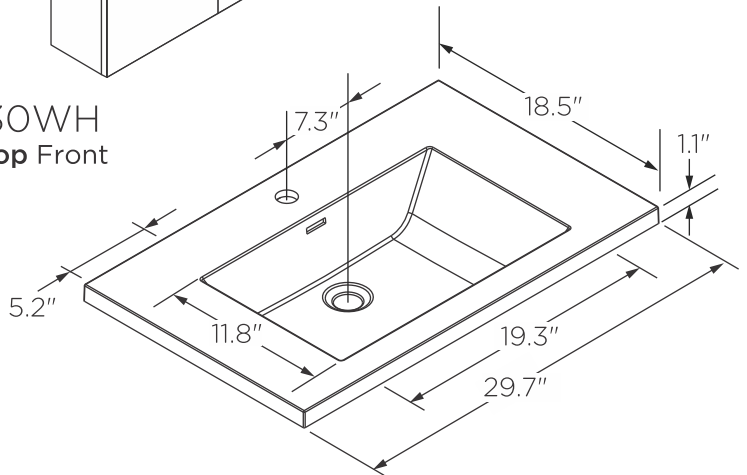

FCB9430
Cabinet Front

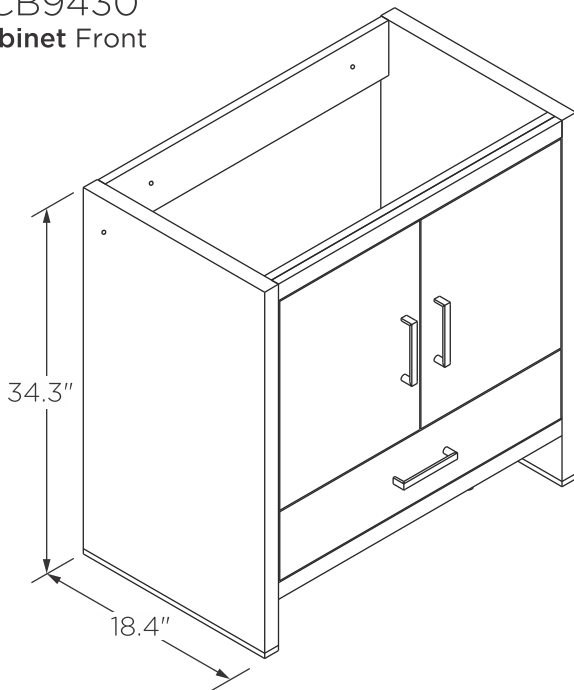

FCB9430
Cabinet Back

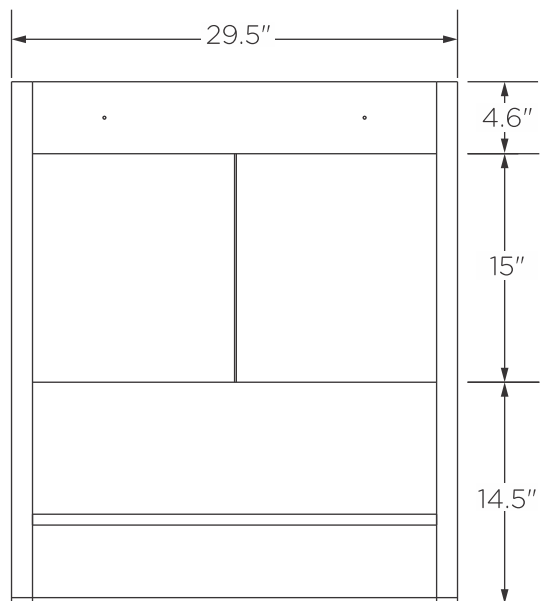

NOTE: All dimensions & specifications are approximate and subject to change without notice.