

Installation Instructions

LED "Flexible Neon" Light Strip

12VDC 3W/ft. and 24VDC 3W/ft.

System Parts: "xx" on part nos. indicates "N1" Side Emitting or "N2" Top Emitting;
 "vv" on part nos. indicates voltage of the light;
 "yy" on part nos. indicates color temperature of the light.

'DIY' (with Starter Cord and Flexible Neon Light Strip sold separately)

- (1) Spool of 'DIY' Flexible Neon (12V) 16.4 ft (5m) . . . P/N: L-xx-vvV3WM-yy-5M-1, or ...
- (1) Spool of 'DIY' Flexible Neon (24V) 26.25 ft (8m) . . . P/N: L-xx-vvV3WM-yy-8M-1
- (1) Power Supply, Class 2: 12VDC 60W max, or 24VDC 96W max
- (1) 'DIY' 12V Flexible Neon Starter Cord 79" (2m) P/N: L-xx12PKT-2M-1, or ...
- (1) 'DIY' 24V Flexible Neon Starter Cord 79" (2m) P/N: L-xx24PKT-2M-1

Typical 12V Installation

Showing example of "DIY" installation with 12V "N2" (top-emitting light) and optional Mounting Block

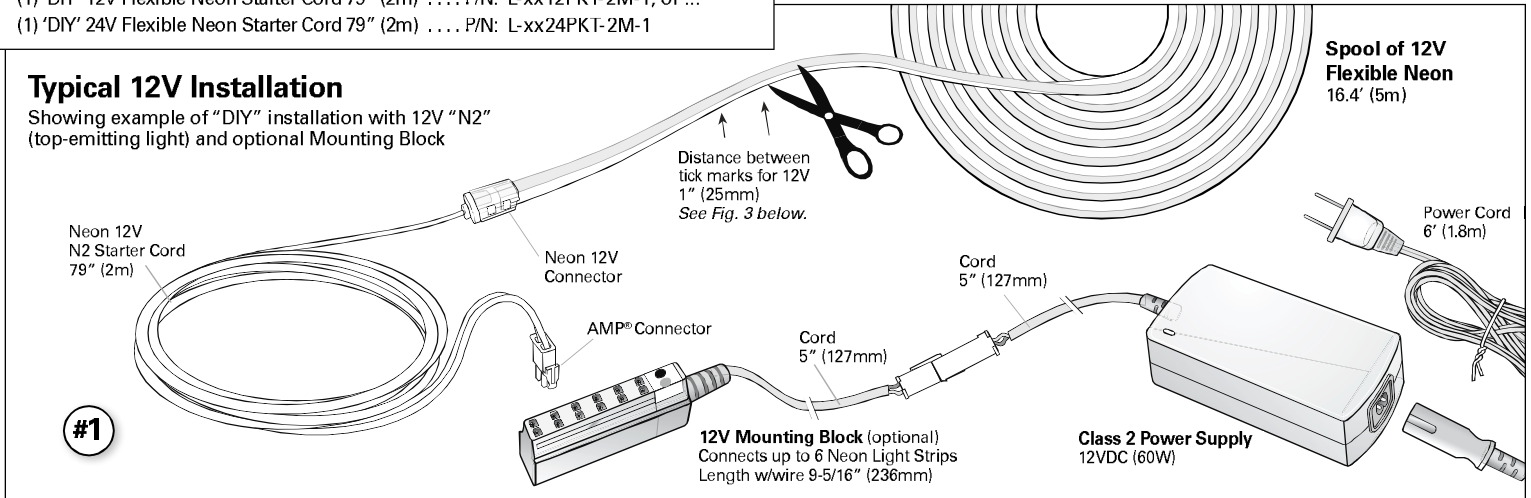

Typical 24V Installation

Showing example of "Custom" installation with 24V "N1" (side-emitting light) and optional 5-Output Barrel Splice

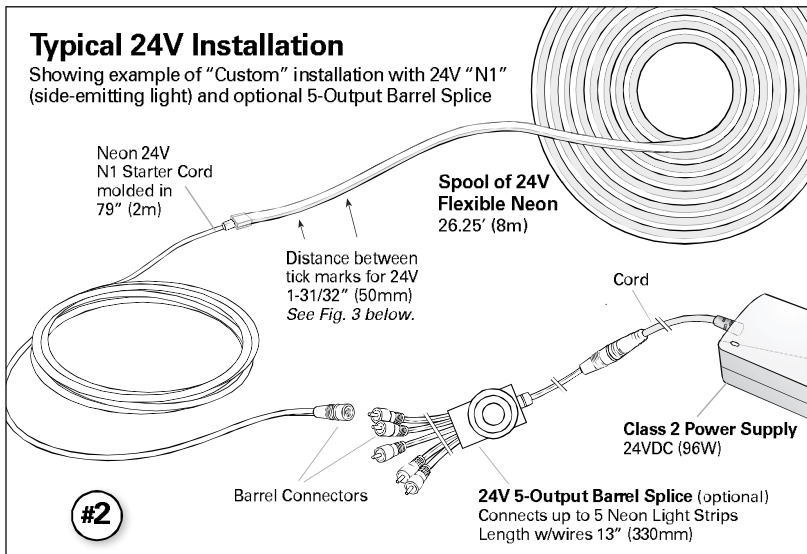

Installing the Flexible Neon Light System:

Roughly lay out the lighting system before installation to verify final positioning of all components. Do not turn power on to light system yet.

To connect multiple Neon Light Strips to one Power Supply, use the optional 12VDC Mounting Block (P/N: L-TRANS-MNT-BL-1) or 24VDC 5-Output Barrel Splice (P/N: L-1BRL5-1) (see Figs. 1 & 2). Mount the Mounting Block or 5-Output Barrel Splice with insulated staples or plastic ties. If Tresco® Mounting Block or Barrel Splice is not used, follow all NEC and local codes. See separate instruction sheets for additional information on installing Power Supplies.

STEPS:

12V SYSTEM:

1. Mount 12VDC Class 2 Power Supply (keep Power Supply in an accessible location).
2. Connect 12V Neon Starter Cord directly to 12V Power Supply.
 Note: if using an optional 12V Mounting Block – connect Power Supply to Mounting Block, then plug 12V Neon Starter Cord into Mounting Block (see Fig. 1).
 Proceed to Step 3 below.

24V SYSTEM:

1. Mount 24VDC Class 2 Power Supply (keep Power Supply in an accessible location).
2. Connect 24V Neon Starter Cord directly to 24V Power Supply.
 Note: if using an optional 24V 5-Output Barrel Splice – connect Power Supply to 5-Output Barrel Splice, then connect 24V Neon Starter Cord to 5-Output Barrel Splice (see Fig. 2).
 Proceed to Step 3 below.

Installing the Flexible Neon Light Strip:

3. Route the Starter Cord so it is positioned where you want the light strip to begin.
4. Cut the Neon Light Strip to length required with scissors or a sharp utility knife. Use the light gray tick marks on the **bottom/mounting** side of the strip as a guide to cut the tape (see Fig. 3 below). Note: cutting anywhere else but on the tick marks will damage the light strip.

Tick Marks on 12V & 24V Neon Lights

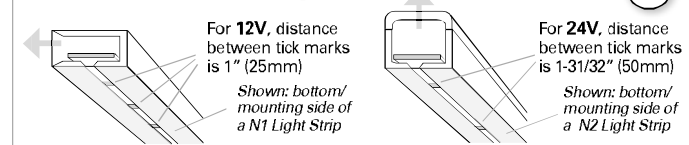

READ ALL INSTRUCTIONS BEFORE INSTALLING SYSTEM.

Before beginning installation, be sure power is turned OFF to light system.

Tresco's LED Flexible Neon Light Strip system is available in "N1" Side Emitting, or "N2" Top Emitting models. In addition, all versions of Tresco Neon come with starter cords premolded onto both ends providing the ability to cut the Neon into two separate runs. For additional runs, a DIY starter cord is required.

To be used with Class 2, 12VDC 60W or 24VDC 96W Power Supplies only.
 This system is dimmable.

NOTATIONS to help determine installation layout:

- Maximum linear run from one Starter Cord of 12V Flexible Neon is 16.4' (5m); and of 24V Flexible Neon is 29.5' (9m).
- For additional linear runs, you must use a new Starter Cord.
- Maximum length of Flexible Neon on all runs from a single 12V/60W Power Supply is **20' (6.1m)**; and from a 24V/96W Power Supply is **26.25' (8m)**.
- Minimum linear run is one 'unit', which is the length between two tick marks. For 12V models, this is 1" (25mm) (see Figs. 1 and 3), and for 24V models it is 1-31/32" (50mm) (see Figs. 2 and 3).
- Use insulated staples and/or plastic ties to secure ALL cords throughout the installation.
- Tresco's Flexible Neon can be used with any Class 2, 12VDC/60W or 24VDC/96W Power Supply. As an option, Tresco® Class 2, 12VDC and 24VDC Power Supplies are available:
 12VDC/60W max. part no.: L-DC-SLELT60-1, and
 24VDC/96W max. part no.: L-24DCELT96-1

For more Power Supply options, see Tresco® Specifications Catalog.

(Instructions continued on page 2)

Accessories: Extension and Link Cords (various lengths), Back-to-Back Connectors, 12V Mounting Blocks, 24V 5-Output Barrel Splices, Mounting U-Clips and Extrusions.

(Continued from page 1)

5. For "DIY" installs only: connect the Starter Cord to the first Light Strip section following the steps below (see Fig. 4 below). For standard install the Starter Cord is already molded to both ends of the Neon, proceed to Step 6.

Note: Applying Connectors to N1 and N2 models are very similar.

a. First, you must check the polarity (+ and -) of the first Light Strip section to the Starter Cord. Insert the 2 metal prongs of the Starter Cord Connector into one end of Light Strip. Temporarily turn on the power to the Power Supply and see if the Strip lights up. If it doesn't light, rotate the Light Strip and insert the 2 metal prongs into the other end of Strip to match polarity. Check that the Strip lights up.

IMPORTANT! The 2 metal prongs of the Connector must be inserted **in between** the LED Tape and plastic strip of the Light Strip. (Fig. 5)

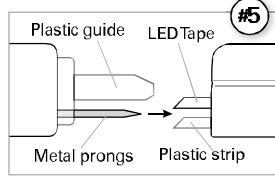

b. Next, apply the Metal Clip flush to end of Light Strip. For both N1 and N2 models, make sure Metal Clip is pushed onto the side **opposite** the light emitting side.

Bend sides of Metal Clip out slightly, push onto Light Strip so it is fully seated and squeeze sides to tighten again. Small metal teeth embed into body of the Light Strip.

c. Snap the clear plastic Base Cover onto both the Connector and Light Strip with Metal Clip attached. Use the index guides on the Connector and Metal Clip to align the Base Cover (see Fig. 4).

d. Then snap the clear plastic Top Cover onto the Base Cover. Push straight down, not angled - tabs will click in. Note: the N1 model is harder to seat, use a countertop or hard surface to snap down.

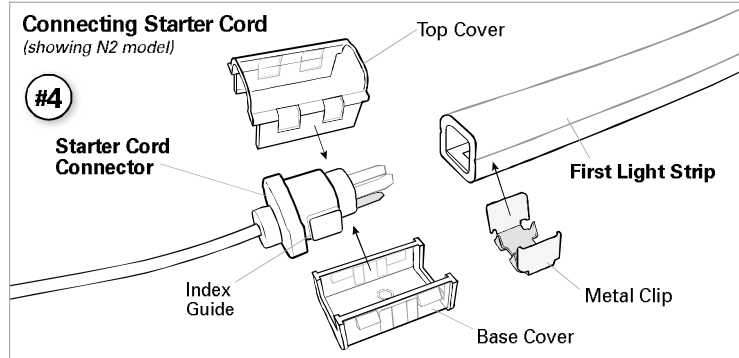

6. To add additional sections use either Linking Cords or Back-to-Back (BTB) connectors (see Figs. below). Before linking together with the Connector assembly, make sure to test for polarity again (see Step 5a above).

To link together Light Strip sections with **Linking Cords**, follow Step 5 above. To link together Light Strip sections with **BTB Connectors**: apply a Metal Clip to end of both Light Strip sections, insert BTB metal prongs into both Light Strip sections following the IMPORTANT note in Step 5a. Snap on Base Cover and then Top Cover. See Tresco® Spec. Guide for complete list of accessories.

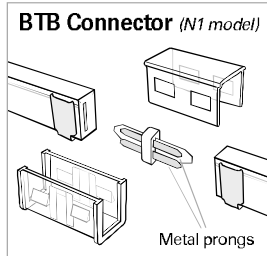
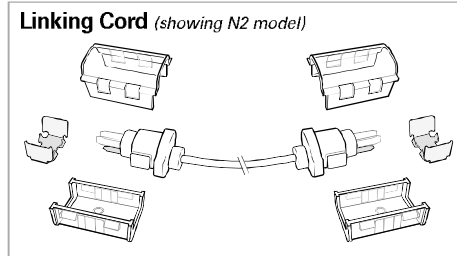

7. After all links are completed, layout the final positioning of the Neon Light Strip run. For surface mounting, you can use U-Clips (1-3/16", 30mm) (see Fig. below). For recessed mounting, cut a groove:

N1: Depth: 12mm (15/32") min. to 13mm (1/2") max.
Width: 6mm (15/64") tight to 6.35mm (1/4") loose.

N2: Depth: 9.5mm (3/8") min.
Width: 10mm (25/64") tight to 10.5mm (27/64") loose.

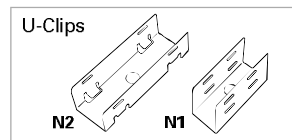

8. Glue a "N1" or "N2" End Cap on the very last section of a run for wet locations.
9. To add more Light Strip runs, repeat the steps above.
10. Double-check all connections and then turn power on to light system.

Installation Do's and Don'ts

- The minimum bend diameter for "N1" and "N2" is 4" (100mm)
- Do NOT twist Neon Light Strips
- Correct bending for N1 showing luminous side facing toward you
- Correct bending for N2 showing luminous side facing up

IMPORTANT SAFETY INSTRUCTIONS

CAUTION: To reduce the risk of fire, electric shock, or injury to persons:

- "DIY" version is NOT intended for outdoor use or where exposed to excessive moisture. "Custom" version can be used outdoors, but NOT intended for corrosive environments or being submerged.
- Do NOT solder your own wires to input/outputs of Flexible Neon Lights. Must use Tresco® Flexible Neon Starter Cords and Connectors.
- Flexible Neon Lights are very flexible, but CANNOT be kinked or creased or the internal contacts may break (see Illustrations above).
- Use proper Class 2, Power Supply for the lighting system – e.g. 12VDC 60W Power Supply with 12V Flexible Neon Lights; and 24VDC 96W Power Supply with 24V Flexible Neon Lights.
- Use only insulated staples or plastic ties to secure cords.
- Route and secure cords so that they will not be pinched or damaged when the cabinet is pushed to the wall.
- NOT intended for use in ceilings, soffits or walls.
- Do not run line voltage power supply cord through holes in walls, ceilings, floors or similar permanent structures.
- If required, a licensed electrician should be consulted for wiring through permanent structures. When mounting and wiring light system, follow all local electric codes and the National Electrical Code (NEC).
- Disconnect electrical power before cutting light or modifying system.
- Individual LEDs cannot be replaced. Instead replace entire Neon Light Strip section.

This light is intended to be used as cabinet fixtures on metal, wood, particle board or other structurally sound, heat-resistant surface. Care should be taken during and after installation to avoid contact of light with wiring, cord, or any combustible material.

*Suitable for use within closet storage spaces.

Save these instructions for future reference. For technical assistance, call 1-800-227-1171



Tresco Lighting by Rev-A-Shelf
12400 Earl Jones Way
Louisville, KY 40299
Tel: 800-227-1171
Fax: 502-491-2215

Email: cservice@trescolighting.com
Web: www.trescolighting.com



kitchensource.com
1.800.667.8721