

FIGURA 2
FIGURE 2



FIGURA 3
FIGURE 3

Paso 2: Inserte la bandeja superior y el marco en la manija (como se muestra en la Figura 2).

Etape 2: Insérer la tablette du dessus et le cadre dans la poignée (Voir Figure 2).

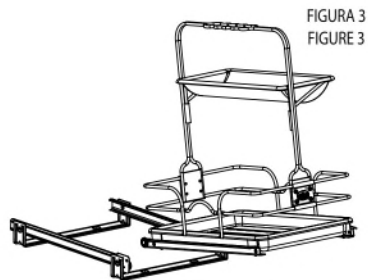

FIGURA 4
FIGURE 4

Paso 4: Asegúrese de que la unidad se deslice dentro y fuera sin ningún problema. De ser necesario, ajuste la canasta en sentido vertical hacia el lado izquierdo o derecho, y apriete los tornillos de la canasta por la parte delantera y posterior de la unidad. (como se muestra en la Figura 4). (Nota: La unidad estará más balanceada si se centra en sentido vertical.)

Etape 4: Vérifier que l'unité glisse complètement sans blocage. Ajuster le montant vers le côté gauche ou droit si nécessaire et continuer l'installation en resserrant les vis du montant du panier à l'avant et à l'arrière de l'unité. (como se muestra en la Figura 4). (Note: L'unité est mieux équilibrée si le montant est centré.)

Paso 3: Coloque la unidad montada en el sistema del riel (como se muestra en la Figura 3), y coloque dentro del gabinete.

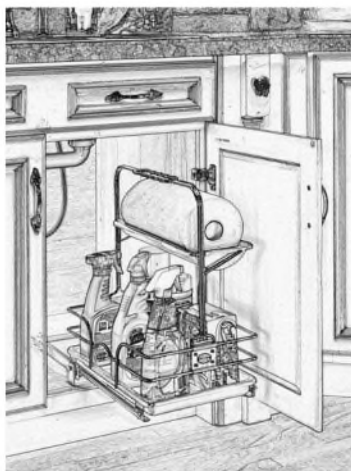
Etape 3: Placer l'unité assemblée dans le système coulissant (Voir Figure 3) et le mettre dans le caisson.



FIGURA 5
FIGURE 5

Paso 5: Saque la canasta de los rieles cerca de 2" y sujete la correa posterior del montaje al piso del gabinete con los tornillos de montaje proporcionados. Quite la canasta del marco y después sujete el frente al piso del gabinete (como se muestra en la Figura 5).

Etape 5: Retirer le panier d'à peu près 5.08 cm (2") hors de la coulisse et attacher la sangle arrière de montage au plancher du caisson avec les vis de montage fournies. Retirer le panier du cadre et attacher alors l'avant au plancher du caisson (como se muestra en la Figura 5).

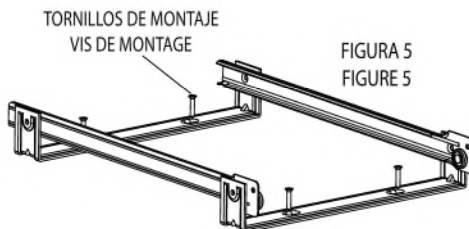

544-10C Installation Instructions

Your sink caddy should be installed on the side of the cabinet that has the least amount of obstructions (i.e. plumbing or a disposal).

Parts Included:



Lower Basket

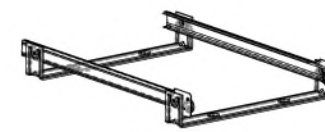

Slide System



Mounting Screws

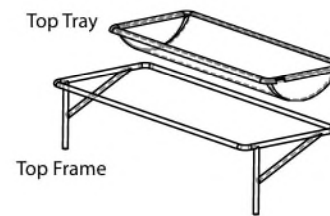

Top Tray

Top Frame

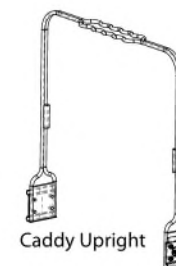

Caddy Upright



Machine Screws

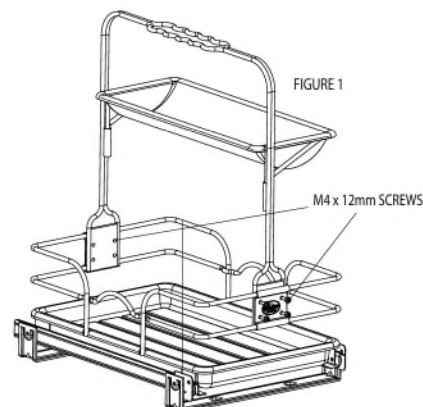
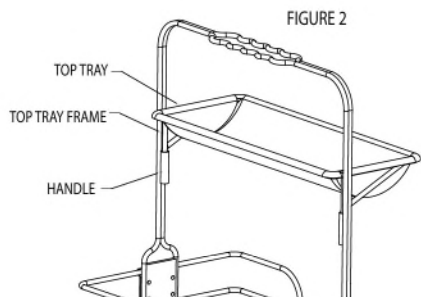

FIGURE 1

M4 x 12mm SCREWS

Step 1: Attach the caddy upright in the center of the lower basket and loosely tighten the M4 x 12mm screws (as shown in Figure 1).



Step 2: Insert top tray and frame into the handle (as shown in Figure 2).



Step 3: Place assembled unit in the slide system (as shown in Figure 3), and place inside the cabinet.

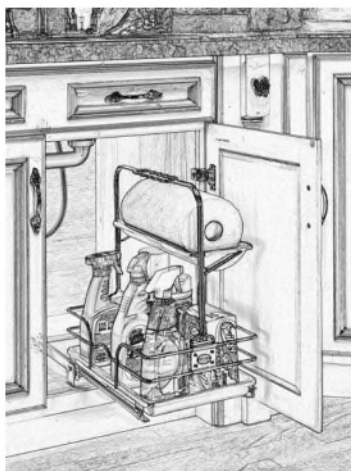
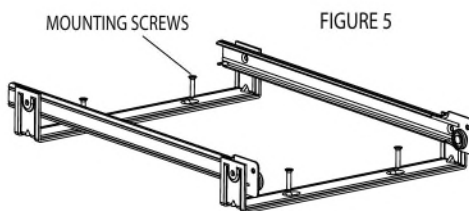

FIGURE 4

Step 4: Make sure that the unit will slide in-and-out without any interference. Adjust the upright to the left or right side, if necessary, and proceed by tightening the caddy upright screws in the front and rear of the unit. (as shown in Figure 4). (Note: The unit is more balanced if upright is centered.)



Step 5: Pull the caddy out of the slides about 2" and fasten rear mounting strap to the cabinet floor with mounting screws provided. Remove the caddy from the frame and then attach the front mounting strap to the cabinet floor (as shown in Figure 5).



Instrucciones de Instalación 544-10C
Instructions d'installation 544-10C

La canasta del fregadero debe ser instalada en el lado del gabinete que tiene la menor cantidad de obstrucciones (por ejemplo, plomería o un triturador).

Votre panier pour évier doit être installé sur le côté du caisson qui a le moins d'encombrement (dû à la robinetterie ou au vide déchet par exemple)

Piezas incluidas:

Pièces incluses:



Cesta inferior
Panier inférieur

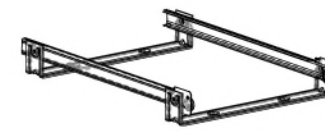

Sistema que resbala
Système qui glisse



Tornillos de montaje
Vis de Montage

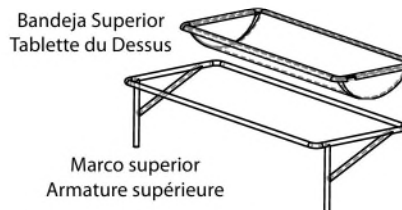

Bandeja Superior
Tablette du Dessus

Marco superior
Armature supérieure

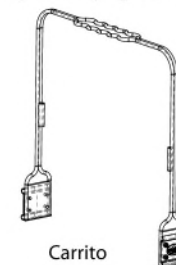

Carrito
Chariot



Tornillos de máquina
Vis de machine

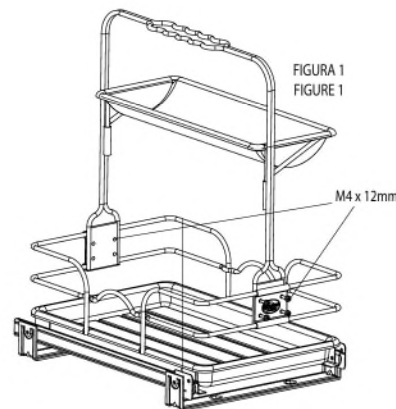

Paso 1: Sujete la canasta en sentido vertical en el centro de la canasta inferior y apriete libremente los tornillos M4 x 12mm (como se muestra en la Figura 1).
Etape 1: Attacher le panier verticalement au milieu du panier du bas et serrer, sans les fixer définitivement, les vis M4 x 12mm (voir Figure 1).