

## ST-2 Spring Tension Track System Face Frame Style

- Important Notes**
- Always read the instructions completely and carefully before beginning assembly.
  - Remove and check contents for damage and/or missing parts. Keep the original cartons and packing materials, which are required for any authorized adjustment by our dealers.
  - These instructions are for reference only. Make sure installation procedures comply with all applicable building codes in your area.

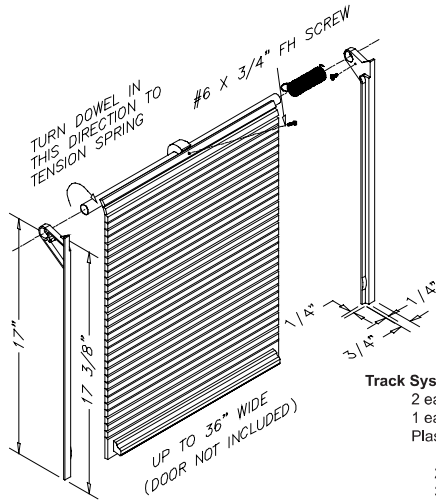

- Track System Includes:**
- 2 ea.- Plastic Track Guides
  - 1 ea.- 5/8" Dowel with Spring
  - Plastic Collar
    - 1 ea.- 16 inch Kit
    - 2 ea.- 24 inch Kit
    - 3 ea.- 30 & 36 inch Kits

Note: 36 Inch kits include a reverse spring for the opposite end of the dowel.

**Features:**

- Spring tension allows for full control of the Tambour Door from top to bottom.
- Available in 16", 24", 30" & 36" widths.
- Made for Face Frame mounting on Straight or Corner Appliance Garages.

Form OME-076, 02/2009  
©Omega National Products

## Installation Instructions

**GENERAL INFORMATION: ST-2**

Maximum Tambour door thickness is .220". Minimum Tambour door height is 18". Maximum recommended Tambour door width is 36". The kit supplied to you has all the necessary components for the width of door ordered (16", 24", 30", 36").

These instructions are written for the corner or straight appliance garage application. If you are planning to use the system in a square cabinet application, some installation procedure changes may be necessary. This system will work equally well in either application. The main procedure changes would be:

- a. The dowel length becomes the inside width of the cabinet less 1/16".
- b. One plastic track guide is installed and then the dowel is inserted before the other track guide is installed.

**Step 1:** Cut the Tambour door to width. Recommended width is the width of the opening plus 7/16". This will allow for a small amount of play in the track system.

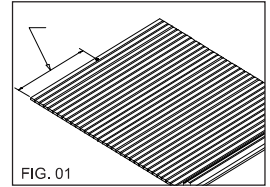

**Step 2:** Cut the Tambour door to height. Recommended height is 18" if the standard length plastic guides are used. Note: For shorter openings, both the Tambour and the plastic guides may be shortened to suit the opening.

**Step 3:** Drill a 5/32" or 3/16" countersunk hole through the center of the top slat of the Tambour door (FIG. 01). Countersink the hole only enough to accept the 6 X 3/4" flat head screw supplied.

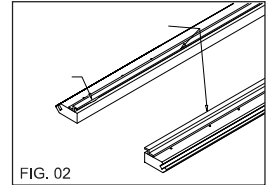

**Step 4:** Make sure that the Tambour door is thoroughly flexed. THIS IS MANDATORY! The system will not work if the Tambour door is not completely flexed. Every single groove must be checked and bent 180° if necessary to ensure flexibility.

**Step 5:** If the stiles of the face frame are exactly parallel, staple the track guides to the back of the frame so that the guides are flush with the inside edges of the stiles (FIG. 02). Locate the staples for attaching the guides to the stiles as shown in FIG. 03. Improper staple location can cause failure. If the stiles are not parallel, attach one track guide to the most plumb stile, then, using a spacer made of 1/8" hardboard, 18" tall by 1/16" wider than the Tambour door, position the second guide. The system works best when the door has about 1/16" side play. The Tambour door should slide freely until it hits the friction bumps located about 1" from the bottom of the guides. If the door does not slide freely except for the friction bumps, determine the cause and correct it before moving on.

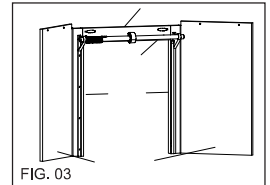

Form OME-076, 02/2009  
©Omega National Products

**Step 6:** Slide the collar onto the dowel to within about 2" from the spring, with the open side of the collar towards the spring (FIGURE #4). Next slip the end of the dowel opposite the spring into the hole in the track guide that does NOT have a screw in it. Then slip the spring end of the dowel into the hole of the track guide with the screw (FIGURE #4 and #5).

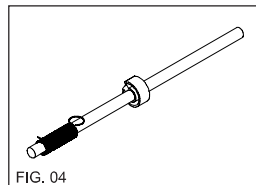

**Step 7:** With the door in the track groove and the screw hole in the door at the top, slide the dowel toward the spring end until the spring is against the track guide. Mark the dowel even with the screw hole in the Tambour door. This mark is used to locate the collar (FIGURE #6).

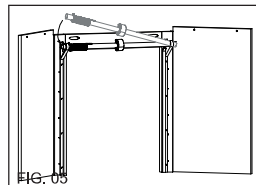

**Step 8:** Slide the collar along the dowel until the closed side of the collar is aligned with the mark you placed on the dowel (FIGURE #7). Secure the collar to the dowel with a 1/2" staple or pin. This prevents slippage during final assembly.

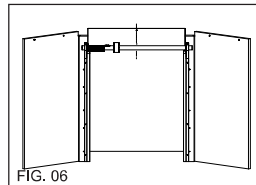

**Step 9:** Position and attach the hand pull to the lower end of the Tambour door. This acts as a stop and is necessary to prevent the door from raising up too far.

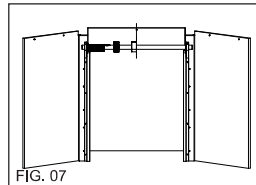

**Step 10:** Wind up the spring by turning the dowel in the direction that will cause the hook on the spring to engage the screw in the track guide. Four or five turns of the spring will be all that is necessary to cause smooth and easy operation

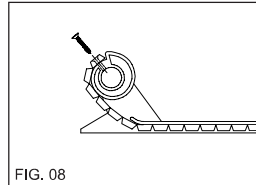

**Step 11:** While the spring is wound up, insert the 6 X 3/4" flat-head screw through the hole in the top of the Tambour door, into the hole in the collar and drive the screw in until it is flush with the surface of the Tambour door (FIGURE #8). DO NOT make the screw tight. Snug it up then back it off about 1/2 a turn. Your door should operate easily and smoothly at this point.

Form OME-076, 02/2009  
©Omega National Products