

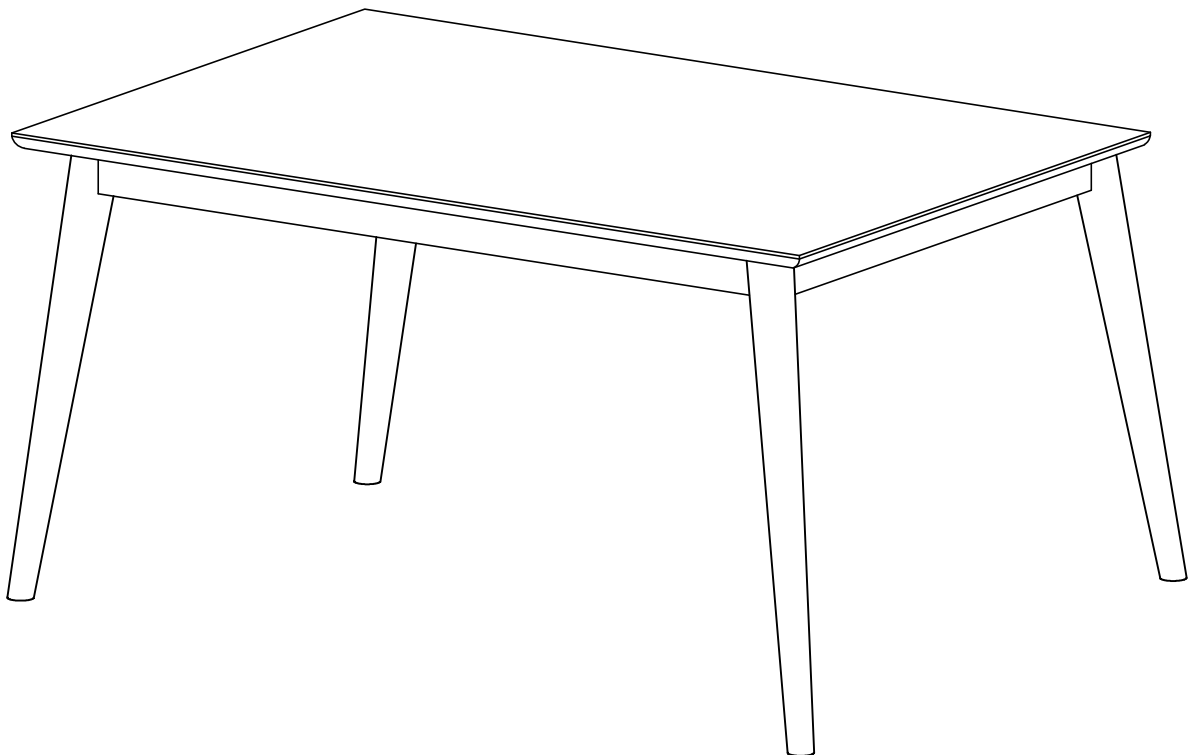







**Rectangular Dining Table
CF2010**

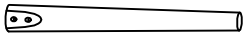

PART LIST

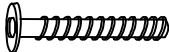
<div data-bbox="145 136 188 174" data-label="Text">A</div> 	<div data-bbox="408 136 451 174" data-label="Text">B</div> 
<p>Table Top 1 PC</p>	<p>Leg 4 PCS</p>

HARDWARE LIST

<div data-bbox="137 734 188 772" data-label="Text">#1</div>  <p>M6 x 60mm</p>	<div data-bbox="400 734 451 772" data-label="Text">#2</div>  <p>1/4"</p>	<div data-bbox="663 734 715 772" data-label="Text">#3</div>  <p>1/4"</p>	<div data-bbox="927 734 978 772" data-label="Text">#4</div>  <p>M4</p>
<p>Bolt 8 PCS (Extra 1)</p>	<p>Spring Washer 8 PCS (Extra 1)</p>	<p>Flat Washer 8 PCS (Extra 1)</p>	<p>Allen Wrench 1 PC</p>

Step 1 . Lay table top (part A) upside down on a soft surface, such as carpet. Attach legs (part B) to table top (part A) using bolts (part #1), spring washers (part #2), flat washers (part #3) and allen wrench (part #4).

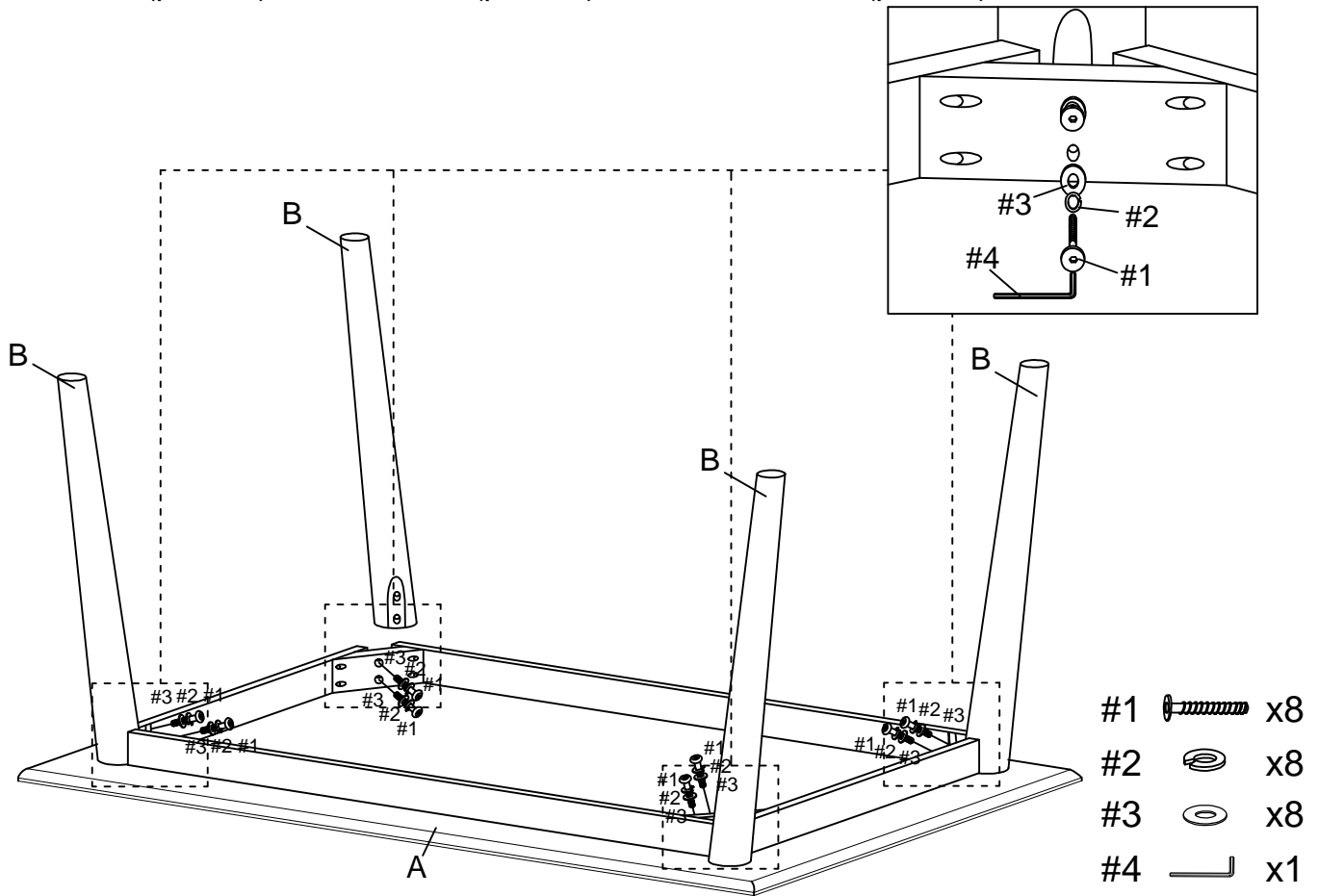

Step 2 . Carefully turn unit upright.

