

KWD110-50

Garbage Disposal

Garbage Disposal Dimensions

Overall Dimensions: 5 1/4" x 8 3/4" x 13 7/8"

Features

- 1/2 Horsepower
- Quick Connect Install
- 3800RPM Motor Speed
- Permanent Magnet Motor Type
- 27 oz. Grind Chamber Capacity
- Stainless Steel Jam Resistant Grinding System
- Continuous Feed
- Splash Guard
- Sink Stopper
- Anti-Vibration Mount
- Manual Reset Overload
- Connection to Dishwasher
- 1 1/2" Drain Connection

Specifications

- Voltage 120V 60Hz
- Amperage 3.25A
- On/Off Control Wall Switch

Available Colors

- Matte Black

Optional Accessories

- Air Switch KWDA-100
- Garbage Disposal Strainer/Stopper GDC-2
- Garbage Disposal Stopper GDC-1
- Garbage Disposal Adapter GDA-2

CODES/STANDARDS:

Product Certification

cUPC, ETL and ISTA certified

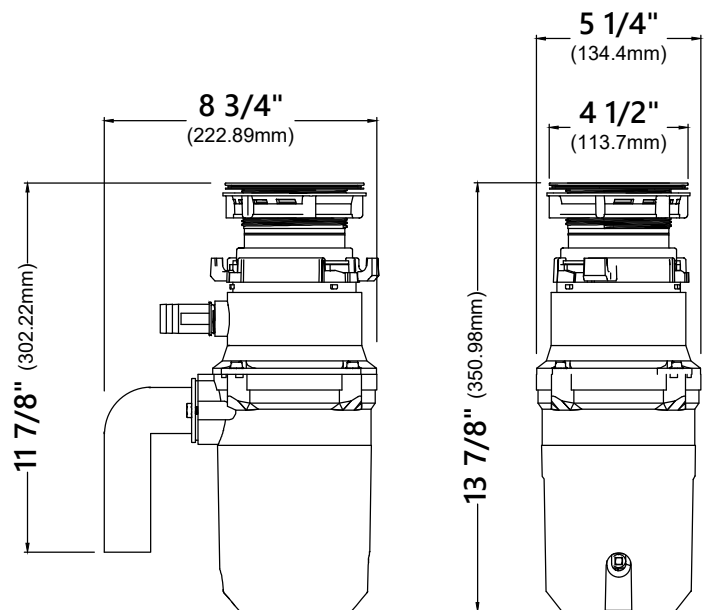

Note: Availability of Kraus Garbage Disposal Accessories may vary based on supply. Universal compatibility with most major brands for quick and easy installation.

Warranty

Kraus Limited 5 Year Warranty

see website for details www.kraususa.com