

FAUCET SPECIFICATIONS

Pull-Down Spray Kitchen Faucet
Model VG02009

MODEL VG02009

FEATURES

- Solid brass construction
- Spiral pull-down spray head
- Spray face that resist mineral build up
- Finish resist corrosion and tarnishing
- Ceramic disk cartridge
- Single hole construction
- 360° Swivel

PACKING LIST

- Faucet Assembly
- Sprayer
- Allen Key
- Two Metal braided hoses
- Weight
- Plastic Holder



DIMENSIONS

MODEL #	HOLE DIAMETER	FAUCET HEIGHT	SPRAYER REACH
VG02009	1 3/8"	18 1/2"	8 1/4"

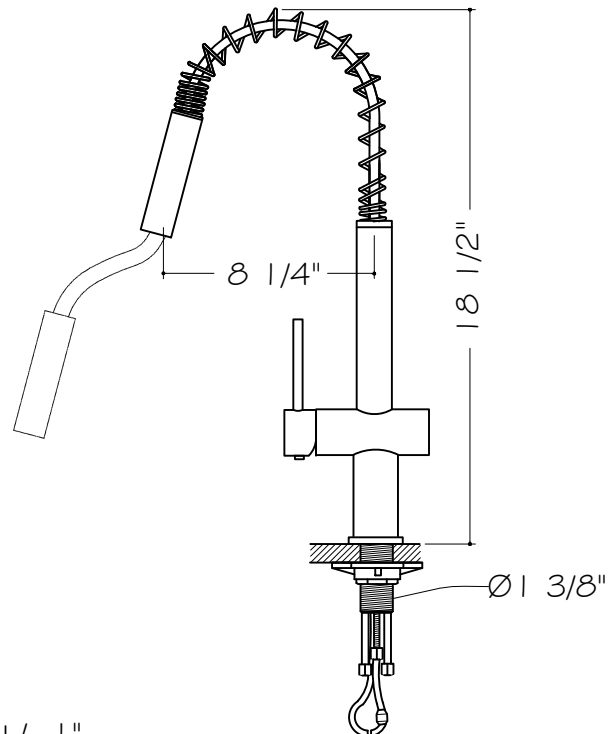

NOTE: All faucets are compliant to CEC 2016 regulations.

* = +/- 1"

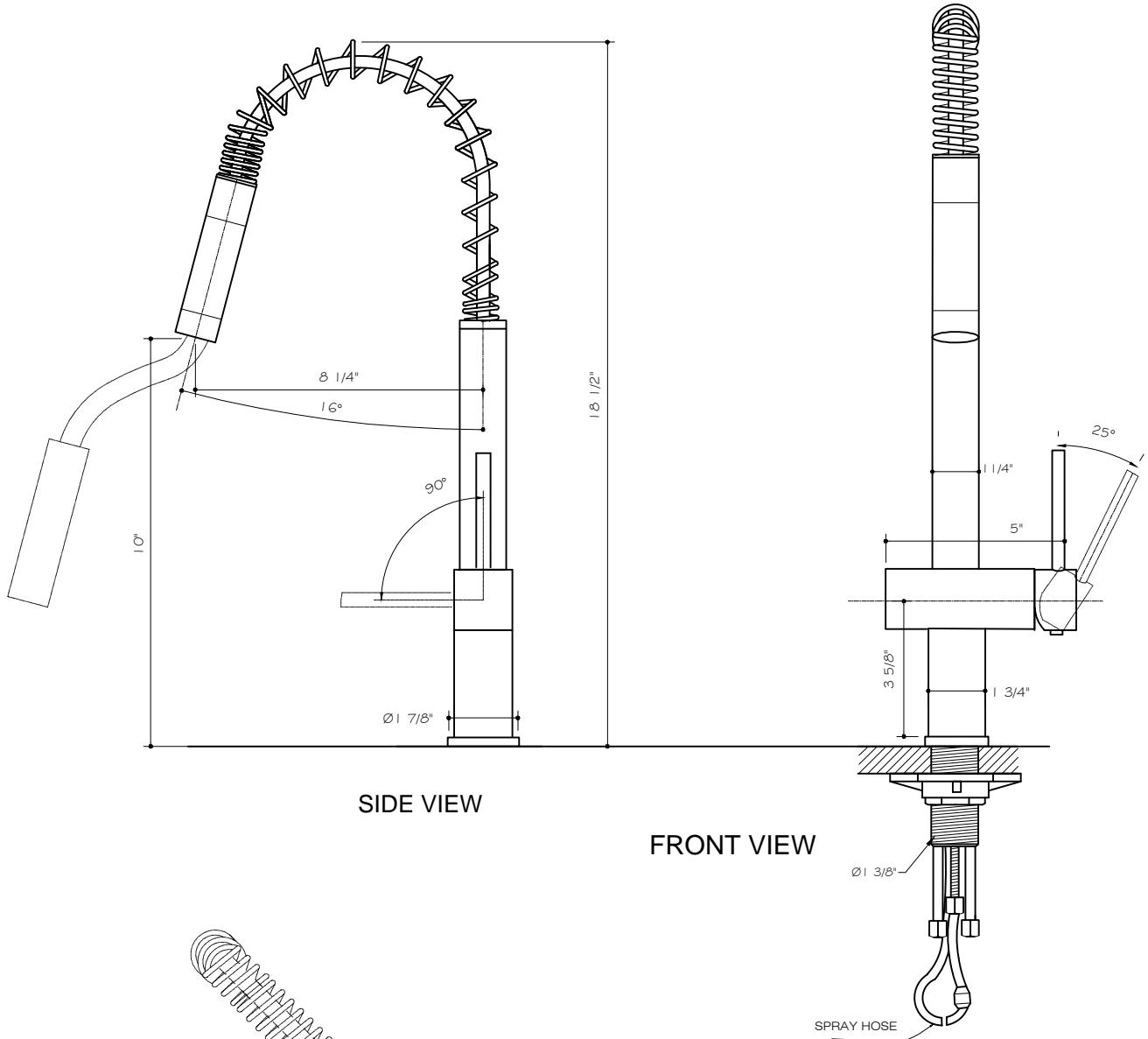

SIDE VIEW

FRONT VIEW

TOP VIEW

VG02009

THE MEASUREMENTS IN INCHES ARE ROUNDED TO THE NEAREST 3/8"

FLOW RATE REGULATIONS

This product meets the CEC requirements. It is up to the discretion of the client to modify the product with the provided restrictor. Doing so will remove the ability for the product to meet certain low flow standards. Please talk to your local or statewide plumbing enforcement agency prior to modifying. Vigo is not responsible for any alterations and the affects that may come with altering the product post sale and highly advises that the client only install the product that meets the needs of their local plumbing code.

Flow rate with restrictor - 1.8 gpm
 Flow rate without restrictor - 2.2 gpm

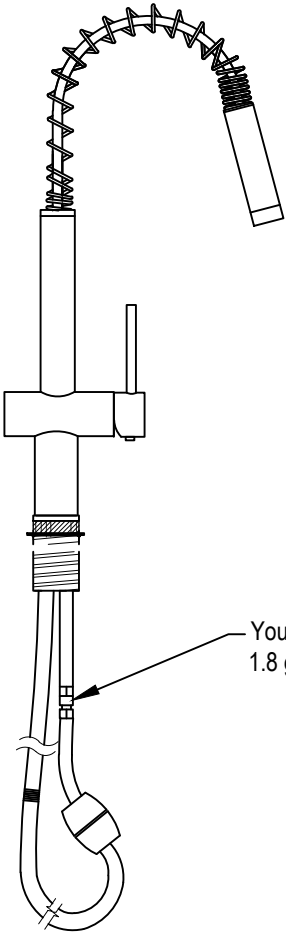
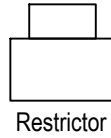

You will find the 1.8 gpm restrictor here. Simply remove the 1.8 gpm restrictor and install the faucet as usual.

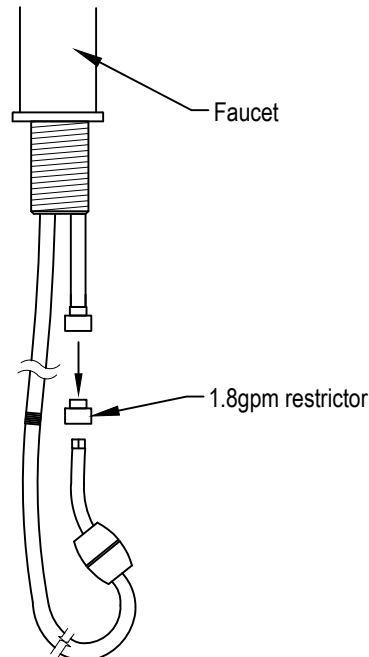

PACKAGE CONTENTS

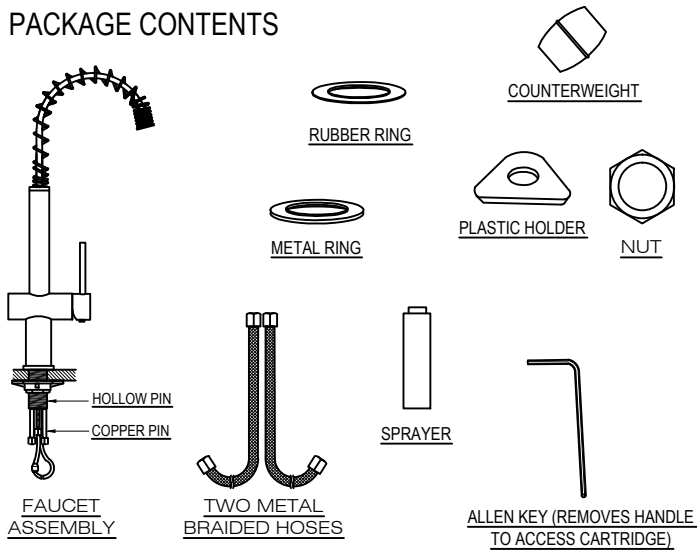

ASSEMBLY

1. SHUT OFF WATER SUPPLY. REMOVE THE OLD FAUCET AND FLEXIBLE HOSES. CLEAN SINK SURFACE WITH A NON ABRASIVE CLEANER IN PREPARATION FOR THE NEW FAUCET.

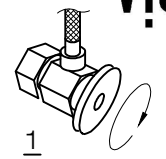

2. THREAD FEMALE END OF METAL BRAIDED HOSE TO THE FAUCET (2).

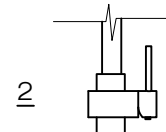

⚠ ENSURE THAT YOU USE PIPE TAPE AND DO NOT OVER TIGHTEN THE SUPPLY LINE NUTS AS THIS COULD CAUSE PRODUCT FAILURE LEADING TO WATER DAMAGE.

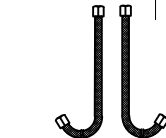

3. POSITION THE FAUCET IN THE COUNTERTOP HOLE, FROM BENEATH THE COUNTERTOP HOLE ASSEMBLE THE PLASTIC HOLDER, RUBBER RING, AND METAL RING IN THE ORDER DEPICTED IN THE DIAGRAM. THEN THREAD METAL NUT ONTO HOLLOW PIN. TIGHTEN THE METAL NUT UNTIL FAUCET IS SECURE.

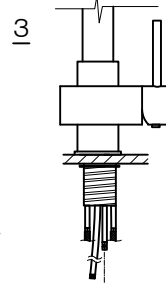

⚠ ENSURE THAT PARTS ARE ASSEMBLED IN THE ORDER AS DEPICTED IN DIAGRAM TO PREVENT DAMAGE TO FAUCET AND SUPPLY LINES.

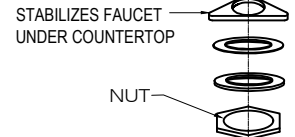

4. SCREW SPRAY HOSE TO THE COPPER PIN (THE LONGEST PIN). MAKE SURE TO HAVE A TIGHT SEAL USING ADJUSTABLE WRENCH. ATTACH SUPPLIED COUNTERWEIGHT TO THE HOSE.

⚠ DO NOT OVER TIGHTEN CONNECT POINT AS THIS COULD CAUSE PRODUCT FAILURE LEADING TO WATER DAMAGE

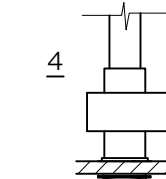

5. (IF NOT DONE ALREADY) ATTACH SPRAYER TO FEMALE CONNECTION OF SPRAYER HOSE BY HAND AND TIGHTEN UNTIL SECURE. MAKE SURE THE BLACK WASHER WITH SCREEN IS SEATED AND INSTALLED PROPERLY.

⚠ USE WASHER WITH SCREEN AT CONNECTION POINT BETWEEN SPRAYER AND SPRAYER HOSE. THIS WILL STOP DEBRIS FROM TRAVELING INTO THE SPRAYER HEAD AND EFFECTING ITS FUNCTIONALITY. PLEASE NOTE THAT THE SCREEN WASHER WILL NEED TO BE REMOVED AND CLEANED APPROXIMATELY ONCE EVERY 3 MONTHS TO AVOID BUILD UP AND LOW WATER FLOW.

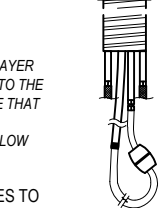

6. ATTACH THE FEMALE CONNECTIONS OF THE FLEXIBLE HOSES TO THE COLD AND HOT WATER SUPPLY.

⚠ ENSURE THAT YOU USE PIPE TAPE AND ADJUSTABLE WRENCH, DO NOT OVER TIGHTEN AS THIS COULD CAUSE PRODUCT FAILURE LEADING TO WATER DAMAGE

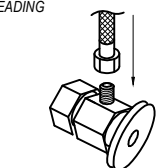

7. AFTER INSTALLATION IS COMPLETE, TURN ON THE WATER SUPPLY AND ALLOW BOTH HOT AND COLD WATER TO RUN SEPARATELY FOR AT LEAST TWO MINUTE EACH. WHILE WATER IS RUNNING, CHECK FOR LEAKS. IT IS IMPORTANT TO VIEW THE CONNECTIONS AT THE MALE AND FEMALE FLEXIBLE HOSE CONNECTIONS. IF LEAKS ARE DETECTED, REFER BACK TO THE INSTRUCTIONS AND ADJUST ACCORDINGLY. TIGHTENING NUTS SLIGHTLY MAY STOP ANY MINOR LEAKS.

REQUIRED TOOLS

- Adjustable wrench
- Allen key - supplied (to remove cartridge if needed)
- Plumber's putty - optional
- Pipe tape
- Flat screwdrivers

SAFETY TIPS

If you use soldering for the installation of the faucet, the seats, cartridges and washers will have to be removed before using flame. Damage caused by improper soldering will void the warranty. Protect your eyes with safety glasses when cutting or soldering water supply lines.

IMPORTANT POINTS

Prior to beginning installation, turn off the cold and hot water lines and open the hot and cold knobs on the old faucet to release pressure. When installing your new faucet, turn the connector nuts finger-tight, then use one wrench to anchor the fitting and a second wrench to tighten the nut. Connections that are too tight will reduce the integrity of the system and potentially cause product failure which could lead to water damage. Wrap all threaded connections with pipe tape available at your local hardware or plumbing supply store. Always wrap in a clockwise direction. Not all necessary supplies to install your faucet are included, however, they are available wherever plumbing supplies are sold. Prior to installing the faucet please FLUSH THE HOT AND COLD WATER SUPPLY LINES that are or will be connected to the new faucet to remove scale, solder or their impurities which could damage the faucet and potentially void the warranty.

MAINTENANCE

Your new faucet is designed for years of trouble-free performance. Keep it looking new by cleaning it periodically with a soft cloth. Avoid abrasive cleaners, steel wool and harsh chemicals as these will scratch, dull, and/or damage the finish and void the warranty.

INSTALLATION

Installation must be done by a qualified licensed plumber. Prior to installation please read the instructions thoroughly, confirm that all parts are included and visually inspect the unit for any defects. If you have any questions please contact the Vigo Technical Support Department before proceeding with installation.

