

Brightwork Home Collection

Hand Hammered Bar/Prep Undermount Kitchen Sink

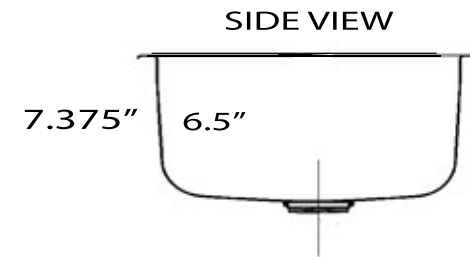

MODEL:
SQRS-7

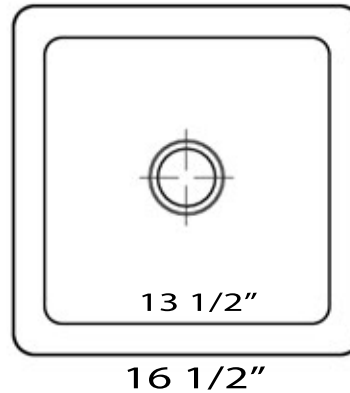

Overall Dimensions	Interior Bowl	Exterior Height	Bowl Depth	Drain Size
16.5" x 16.5"	13.5" x 13.5"	7.375"	6.5"	3.5"

FEATURES

- 18 Gauge Stainless Steel
- Nominal dimensions - may vary by .25"
- Limited Manufacturers Warranty (not for finish)
- Like all stainless may dull (patina)- polish to bring back luster
- Hand Hammered - each piece is unique
- Drain is not included with sink (NS35LCC-CH shown)



PROJECT/ NAME:

ARCHITECT/CONTRACTOR:

MODEL:

JOB NOTES: