



Tiempo estimado de ensamblado:  
Durée de l'installation:

### 20 MIN

VER VIDEOS DE INSTALACIONES DE PRODUCTOS  
REGARDEZ DES VIDEOS D'INSTALLATION DE PRODUITS

WWW.REV-A-SHELF.COM/VIDEOS

Cuidado! Atención:

Limpie con un paño húmedo y seque las partes.  
Lubrique los puntos de los pivotos como sea necesario.

Nettoyez avec un chiffon humide et essayez pour sécher complètement. Lubrifiez les points de pivotement si nécessaire.

LISTA DE PARTES / LISTE DES PIÈCES	
Description / La description	#
Caja Metálica / Boîte en métal	1
Deslizantes / Couloises	2
Cubiertas Deslizantes / Couvertres des couloises	2
Soportes de Montaje para Puerta / Supports de Montage de Porte	2
Cesto de ropa / Panier à linge	2
Tornillos / Vis	
Tornillos de Cabeza plana del #12x5/8" / Vis à tête plate #12x5/8"	12
Tornillos de Máquina M4x5 / Vis machine M4x5	4
Tornillos de Cabeza Plana del #6x1/2" / Vis à tête plate #6x1/2"	6
Tornillos de Máquina de 1/4-26x1/2" / Vis machine 1/4-26x1/2"	2

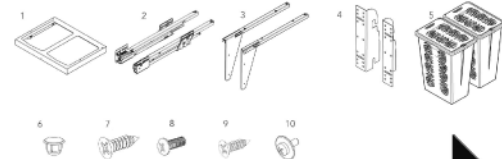

**LH**

**PASO 1 / ÉTAPE 1**

Coloque la plantilla y marque las ubicaciones de los orificios para la guía superior izquierda. Luego, sujete cada deslizante usando cuatro tornillos de cabeza plana del #6x1/2" (ver la Figura 1). Gire la plantilla y realice lo mismo con la guía inferior derecha.

Placez le gabarit et marquez l'emplacement des trous pour la glissière supérieure gauche. Ensuite, fixez chaque couloise avec 4 vis à tête plate #6x1/2" (voir figure 1). Retournez le gabarit et faire de même pour la glissière droite inférieure.

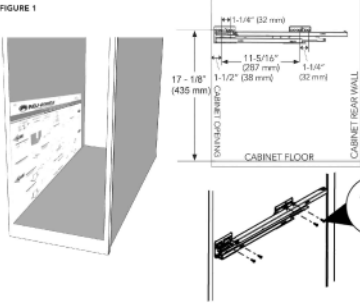

**PASO 2 / ÉTAPE 2**

Coloque las cubiertas deslizantes sobre los deslizantes (ver la figura 2).  
Placez les couvertres des couloises sur les couloises (voir l'illustration 2)

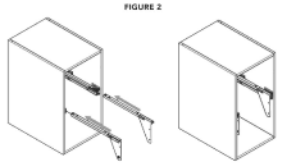

**PASO 3 / ÉTAPE 3**

Extienda los deslizantes y monte la caja metálica usando los cuatro tornillos de máquina M4x5 (ver la figura 3). Coloque los cuatro tapones sobre los tornillos cilíndricos.

Étendez les couloises et montez la boîte en métal avec les 4 vis machine M4x5 (voir l'illustration 3). Placez les 4 fiches sur les vis cylindriques.

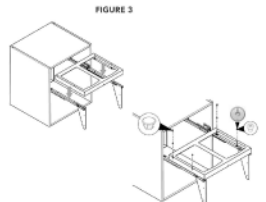

**RH**

**PASO 4 / ÉTAPE 4**

Marque y pre taladre orificios de montaje usando las medidas en las figuras 5 y 6. Sujete los soportes de montaje usando seis tornillos de cabeza plana del #6x1/2".

Marquez et pré-percez les trous de montage en utilisant les mesures des illustrations 5 et 6. Fixez les supports de montage de porte avec 6 vis à tête plate #6x1/2".

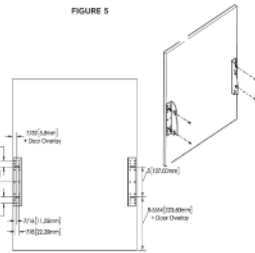

**FIGURE 6**

CÓMO DETERMINAR LA PUERTA SOBREPUESTA:  
COMMENT DÉTERMINER VOTRE APPLIQUE DE PORTE:



**PASO 5 / ÉTAPE 5**

Alinee los soportes de la puerta a las cubiertas de los deslizantes y sujete con dos tornillos de máquina de 1/4-26x1/2" y con arandelas (ver la figura 7).

Alignez les supports de porte aux couvertres des couloises et fixez avec 2 vis 1/4-26x1/2" et rondelles (voir l'illustration 7).

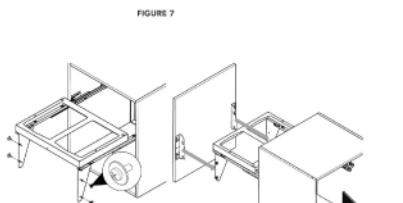

**RH**

**LH**

**PASO 6 / ÉTAPE 6**

Ajuste la puerta usando los tornillos de ajuste (ver la figura 8) hasta que la puerta esté centrada y al ras con el marco.

Régulez la porte avec les vis de réglage (voir l'illustration 8) jusqu'à ce que la porte soit centrée et alignée avec votre cadre.

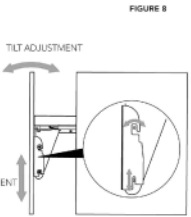

**PASO 7 / ÉTAPE 7**

Coloque el cesto de ropa en el chasis como se muestra.  
Placez le panier à linge sur le châssis, comme indiqué.

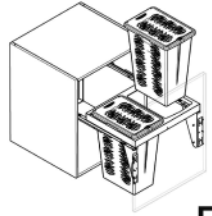

<b>TOOLS REQUIRED:</b> 	<b>ESTIMATED ASSEMBLY TIME:</b> <h3>20 MIN</h3> <p>WATCH TUTORIALS OF OUR PRODUCTS BEING INSTALLED</p>  <p>WWW.REV-A-SHELF.COM/VIDEOS</p>	<b>CARE AND MAINTENANCE:</b> <p>CLEAN WITH A DAMP CLOTH AND WIPE PARTS DRY</p>
---	---	---

Parts List		
No.	Description	Qty
1	Hamper Chassis	1
2	Slides	2
3	Slide Covers	2
4	Door Mounting Brackets	2
5	Hampers	2
6	Flags	4
7	#12x5/8" Flathead Screws	12
8	#6x5 Machine Screws	4
9	#6x1/2" Flathead Screws	6
10	1/4-20x1/2" Machine Screws	4

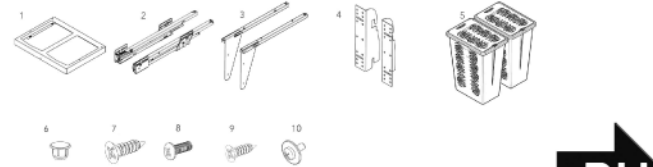

LH

RH

**STEP 1**

Place template and mark hole locations for the left hand slide. Then attach each slide using (4) #6x5/8" flathead screws (See Fig 1). Flip the template and do the same for the right hand side.

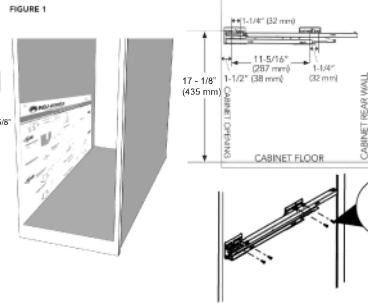

**STEP 2**

Place the slide covers over the slides (See Fig 2).

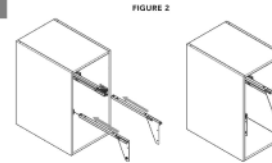

**STEP 3**

Extend the slides and mount the chassis using the (4) #6x5 machine screws (See Fig 3). Place the (2) plugs over the cylindrical screws.

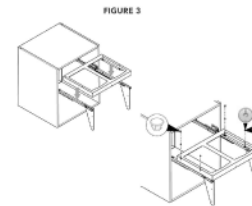

**STEP 4**

Mark and pre-drill mounting holes using measurements in figures 5 and 6. Attach door mounting brackets using (6) #6x1/2" flathead screws.

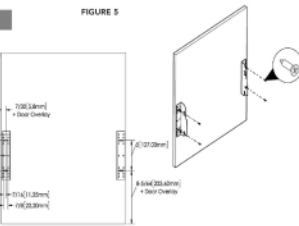

**FIGURE 6**

**HOW TO DETERMINE YOUR DOOR OVERLAP:**

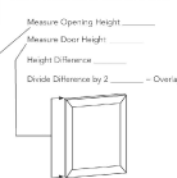

**STEP 5**

Align the door brackets to the slide covers and attach with (2) 1/4-20x1/2" machine screws and washers (See Fig 7).

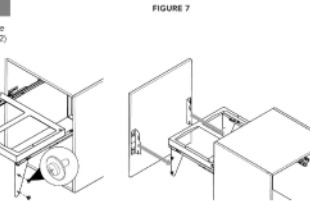

LH

RH

**STEP 6**

Adjust the door using the adjustment screws (See Fig 8) until the door is centered and flush with your frame.

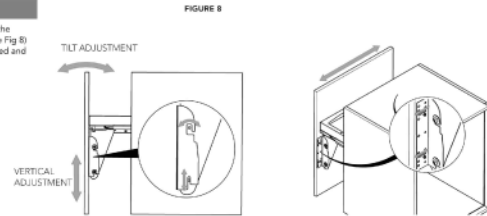

**STEP 7**

