

FMC8015

FRESCA 15" WIDE BATHROOM MEDICINE CABINET INSTALLATION GUIDE

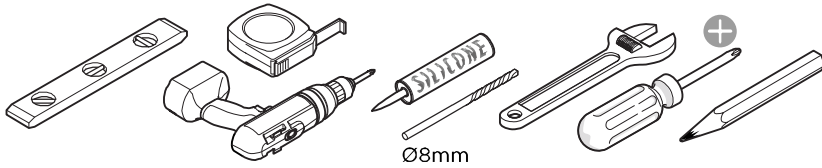

TOOLS REQUIRED FOR INSTALLATION:



DIMENSIONS

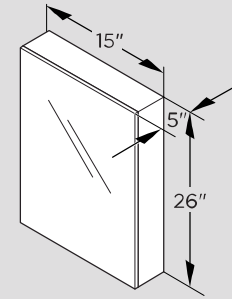

All dimensions & specifications are approximate and subject to change without notice.

INCLUDED IN THE PACKAGE:

- A. Medicine Cabinet
- B. Side Bracket (X4)
- C. Side Mirror (X2)
- D. Small Screw (X4)
- E. Glass Shelf (X2)
- F. Anchor (X4)
- G. Screw (X4)
- H. Top Mounting Bracket
- I. Bottom Mounting Bracket
- J. Snap-in Shelf Pin (X8)
- K. Hole Plug (X29)

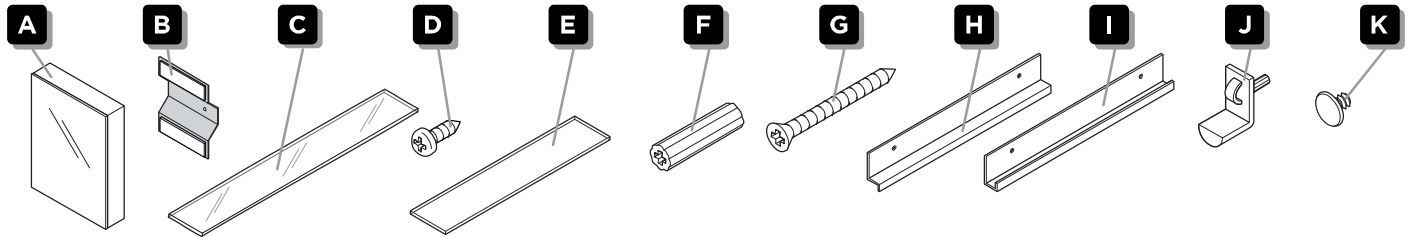

INCLUDED IN THE PACKAGE:

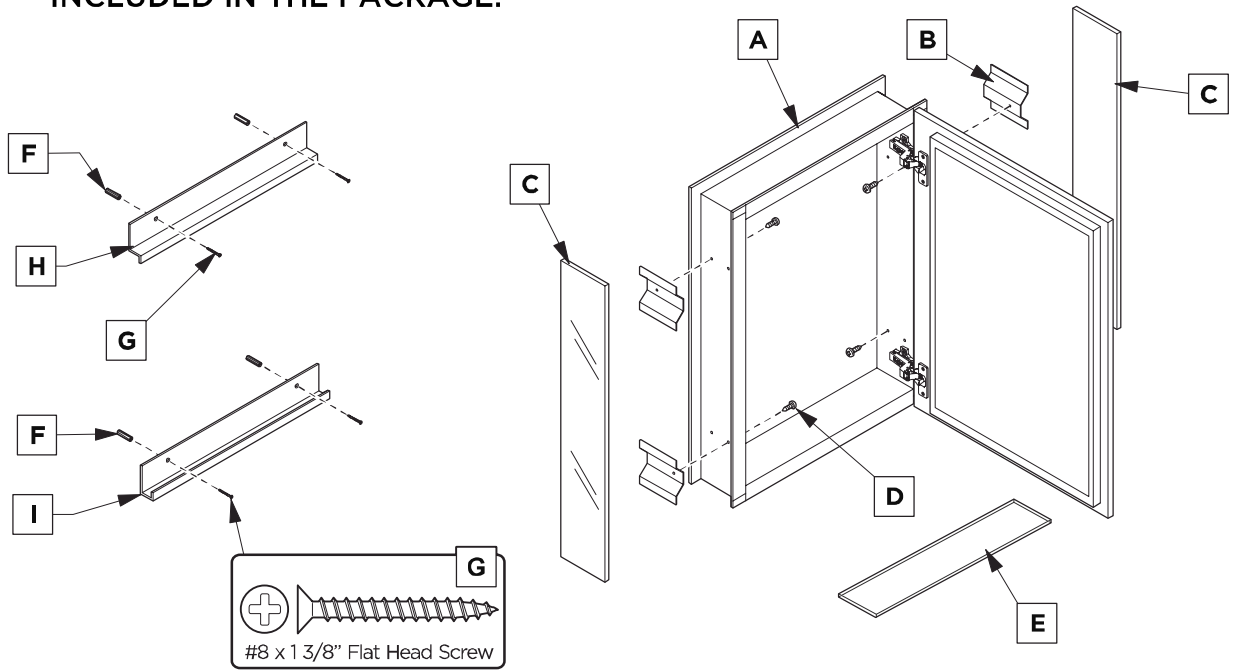

WARNING

➤ Risk of property damage. Use anchors rated for the loaded weight of the product. Refer to anchor manufacturer's instructions.

DANGER

➤ Risk of electric shock. Avoid existing electrical wiring or plumbing when mounting this product to the wall.



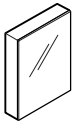

FMC8015

FRESCA 15" WIDE BATHROOM MEDICINE CABINET INSTALLATION GUIDE



surface-mount installation

1.

Mark the medicine cabinet's location from point **a** to point **b** using a level.

2.

3" min.
CLEARENANCE

D Install the bottom bracket.

A Level and mark.
B Drill the hole with a 3/16" bit.
C *Insert the anchors (F).

CONSULT AN EXPERT FOR THE PROPER SCREWS/BOLTS TO USE WHEN ATTACHING TO VARIOUS WALL CONSTRUCTION TYPES.

3.

With assistance, rest the cabinet on the mounting bracket (**I**) and fold it in place.

4.

Hold the cabinet then fit the top bracket (**H**) on to the top of the cabinet then attach the bracket to the wall.

5.

Align mirrored side panel (**C**) each side of the cabinet.

6.

Secure mirrored side panels with provided screws (**D**) using screwdriver.

7.

Push and twist the snap-ins (**J**) into place.

8.

Fill remaining holes with the plugs (**K**).

9. FOR THE OPTIONAL DOOR ADJUSTMENT REFER TO PAGE #2.

① Push a side of the glass shelf (**E**) into the left or right pins (**J**).
② Push a side of the shelf (**E**) down into the opposite side.

All dimensions & Specifications are approximate and subject to change without notice.

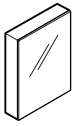

FMC8015

FRESCA 15" WIDE BATHROOM MEDICINE CABINET INSTALLATION GUIDE



recess-mount installation

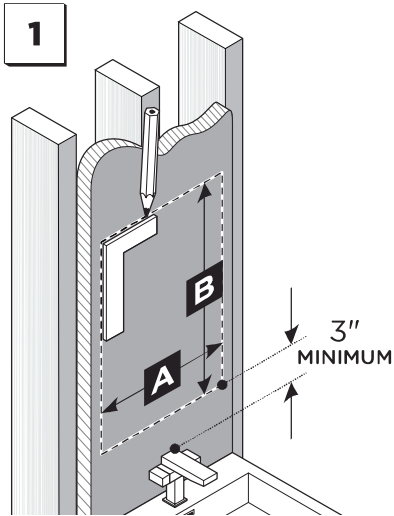

1 Draw the perimeter of the medicine cabinet on the wall.

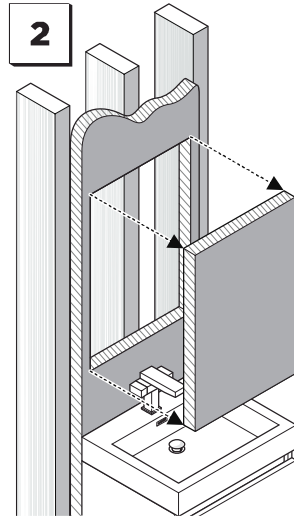

2 Cut the marked perimeter with the appropriate tool.

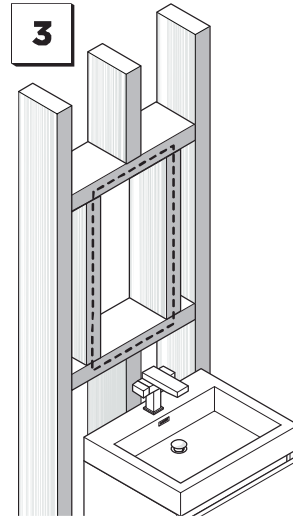

3 Frame the cutout opening.

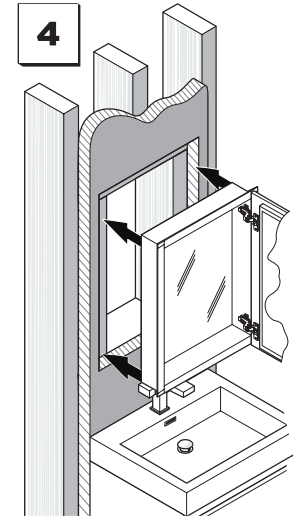

4 Place and hold the cabinet in the cutout opening.

DIMENSIONS FOR RECESS-MOUNT INSTALLATION

model #	width A	height B	depth
FMC8015	14 1/8"	25 1/8"	3 3/4"

4 STEPS TO FRAME THE CUTOUT OPENING

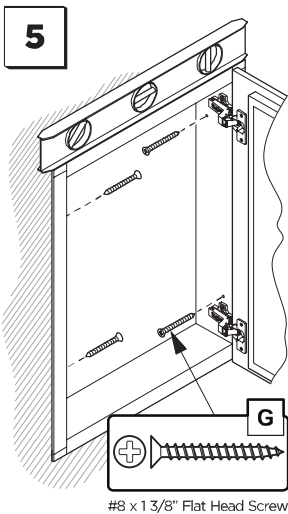

5 Level, then secure the cabinet with screws (G) through the mounting holes into the wall or the mounting studs.

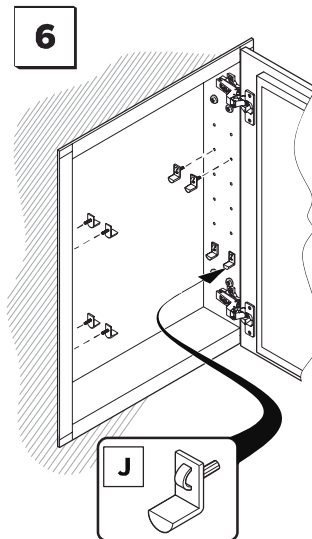

6 Choose the position for your shelves then push and twist the snap-in pins (J) into place.

7 GLASS SHELF INSTALLATION

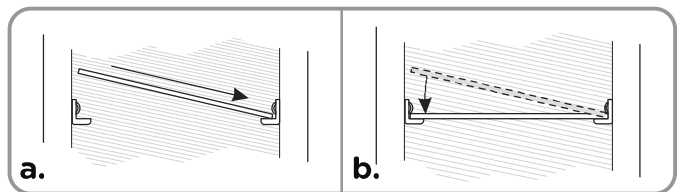

a. Push a right side of the shelf (E) into left or right pins (J).
b. Snap the shelf (E) down into opposite side.
c. Fill remaining holes with the plugs (K).

OPTIONAL DOOR ADJUSTMENT:

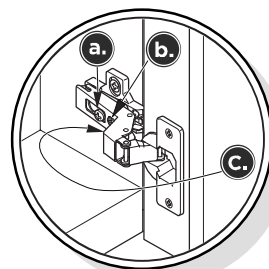

- A** This screw allows you to adjust pitch side to side.
- B** This screw releases cabinet's door and allows up & down adjustment.
- C** This screw allows you to adjust the gap between the doors.

All dimensions & specifications are approximate and subject to change without notice.



FMC8015

INSTALLATION GUIDE

kitchensource.com

1.800.667.8721

PAGE 3