

88 5561 30 Dining Table

IMPORTANT NOTE

This product is made from sturdy, high quality aluminum and will provide years of enjoyment. Do not use power tools to assemble and only tighten bolts until they are snug.

Carefully remove all the parts from the carton and put them individually on a soft cloth to prevent scratches or other damage occurring to the parts.

We have taken great care in the design of this product and request that you carefully and strictly follow our assembly instructions to ensure a completed product as it was designed.

Home Styles



Part List

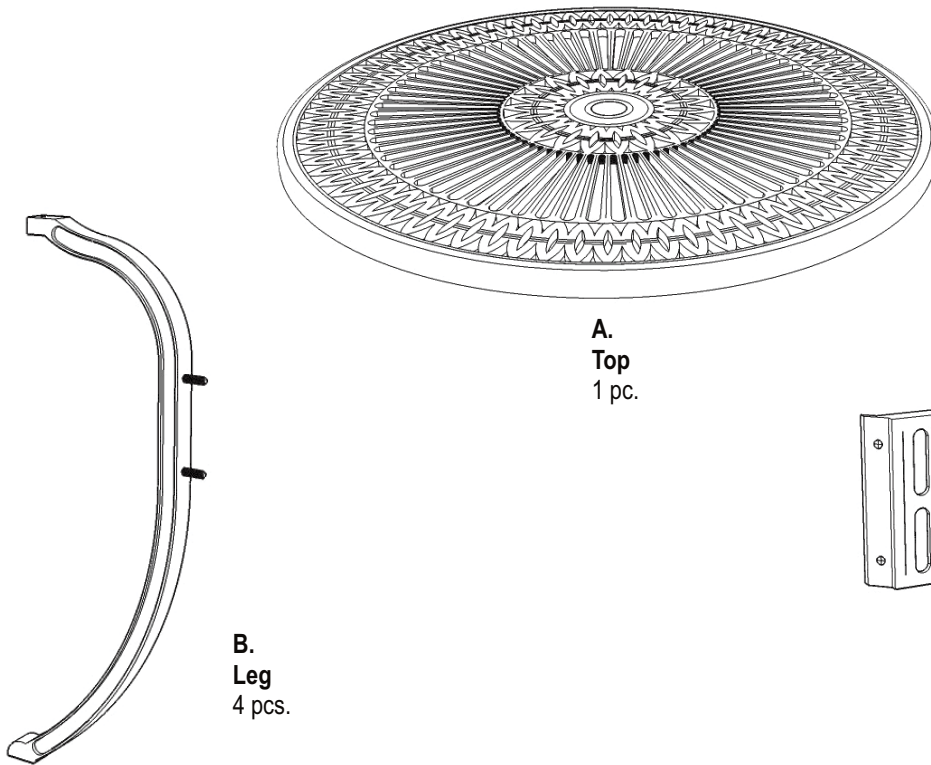

A.
Top
1 pc.

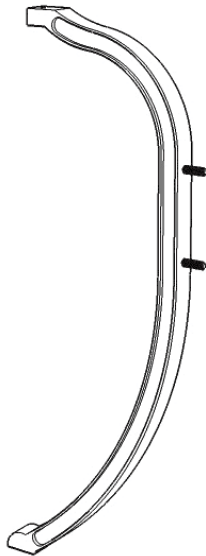

B.
Leg
4 pcs.

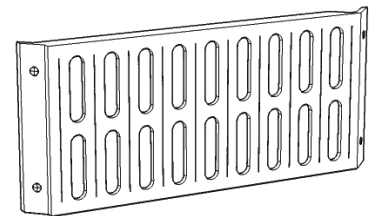

C.
Side Frame
4 pcs.

Hardware List



Key Wrench
1 pc.



Flat Washer
12 pcs. (+1 extra)



Nut
12 pcs. (+1 extra)



Cover
1 pc.



M8x40 Bolt
4 pcs. (+1 extra)



Spring Washer
12 pcs. (+1 extra)



Nut Cap
12 pcs. (+1 extra)

Tools required for assembly : Slotted screwdriver

Tools recommended for assembly : Level

IMPORTANT

- * Please keep Key Wrench in a safe place as you may need to tighten up the Nuts in the future.
- * Use a soft cloth between these parts and the floor.
- * Do not use power tools to assembly and do not tightening the bolts and nuts.
- * Do not tighten up all the bolts and nuts until each part is properly assembled.
- * After assembly item must be level to work properly. Use the included adjustable levelers to level.

STEP 1

Attach Legs (B) to Side Frames (C) with Flat Washers, Spring Washers, Nuts and Nut Caps. (See Figure 1 and Figure 2)

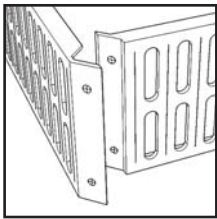

Figure 1

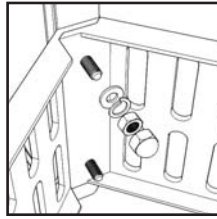
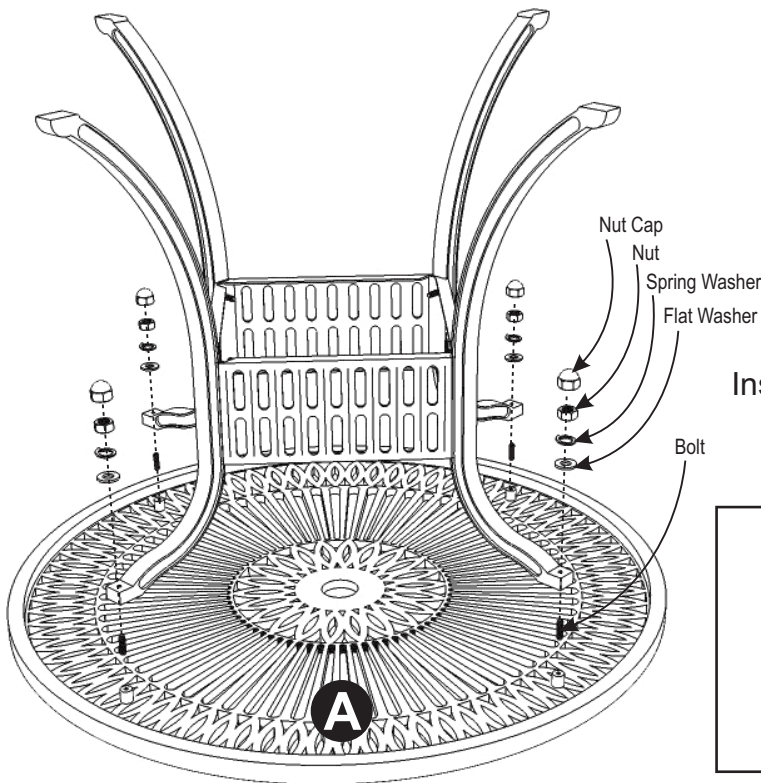
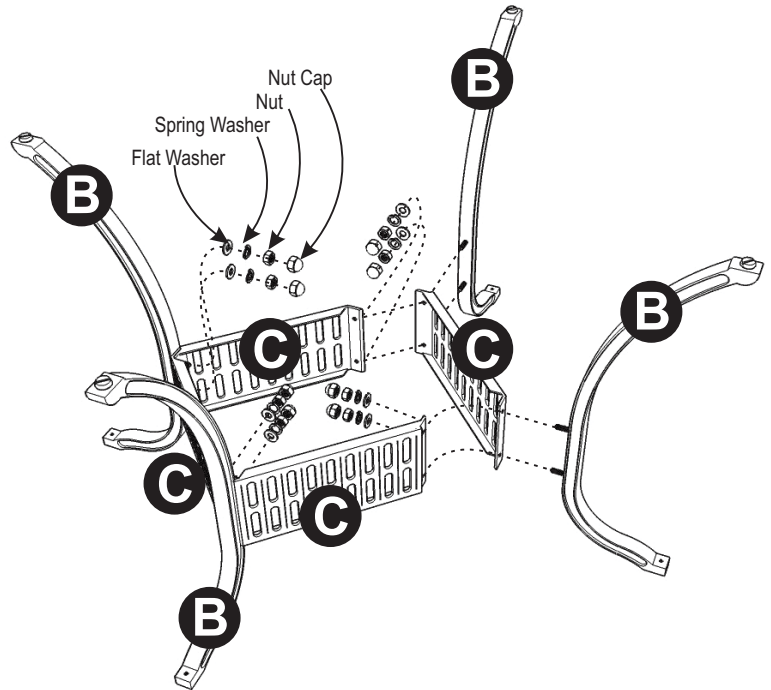

Figure 2



STEP 2

Place Top (A) upside down on a soft cloth.

Insert Bolts into the pre-drilled holes of Top (A).
(See Figure 3)

Attach unit to Top (A) with Flat Washers, Spring Washers, Nuts and Nut Caps.

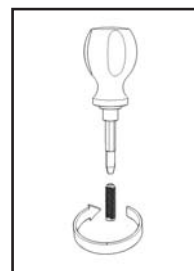

Figure 3



STEP 3

Turn the unit over to its' upright position.

Cover the umbrella hole with Cover.

To level the unit, adjust the adjustable levelers on the bottom of the legs.
(See Figure 4)

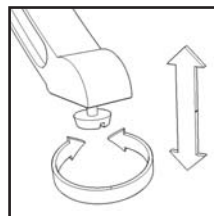

Figure 4