

DRAIN DIAGRAMS

D1040F-XX

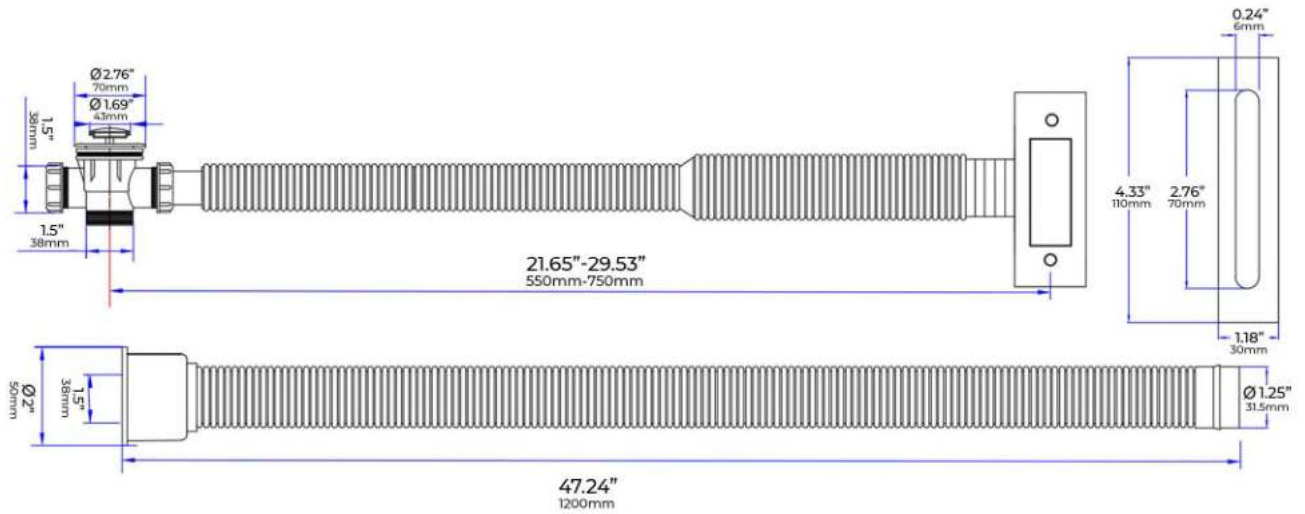

D1845-XX

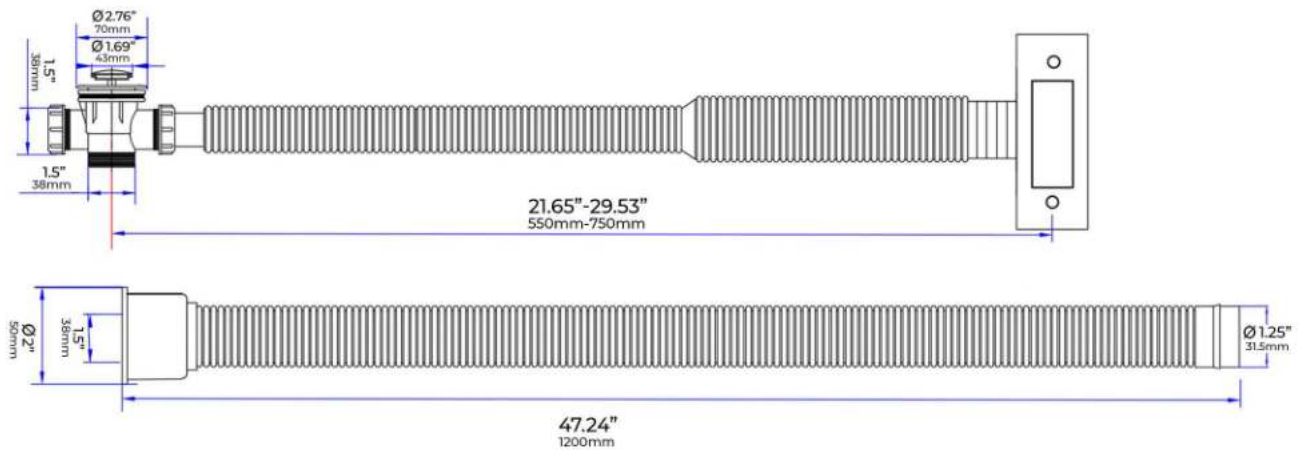

**XX REPRESENTS DIFFERENT COLORS OF THE ITEM

DRAIN DIAGRAMS

D1040C-XX

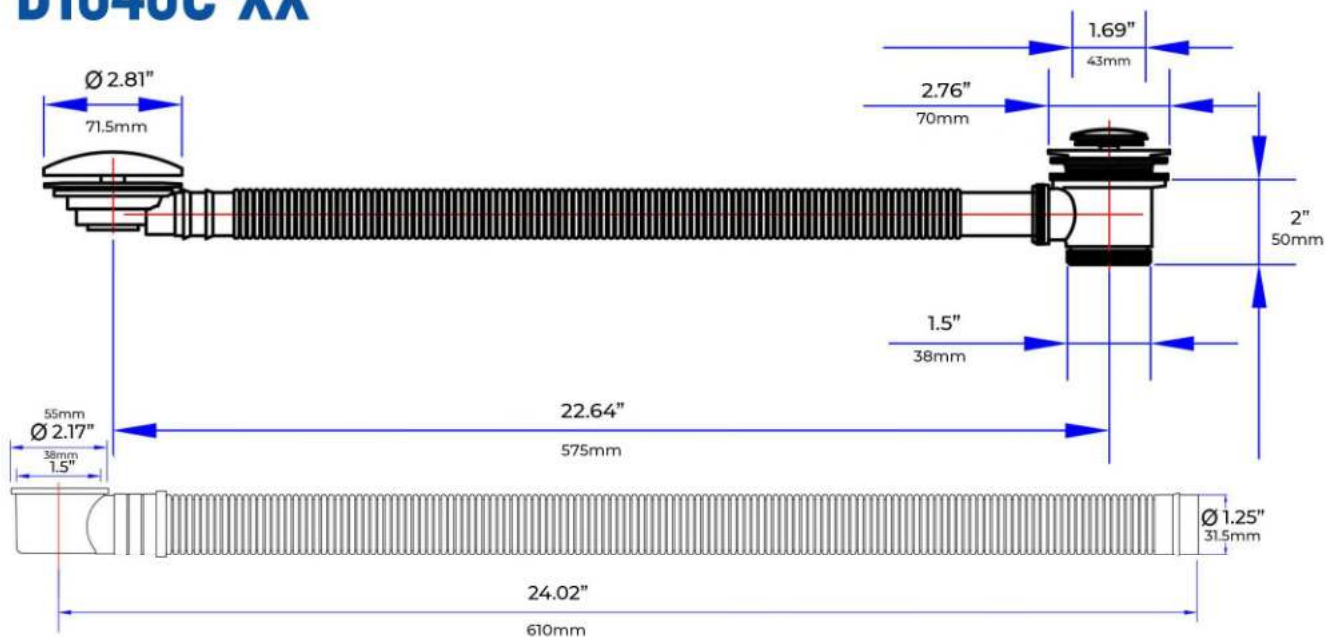

N-PU1606-XX

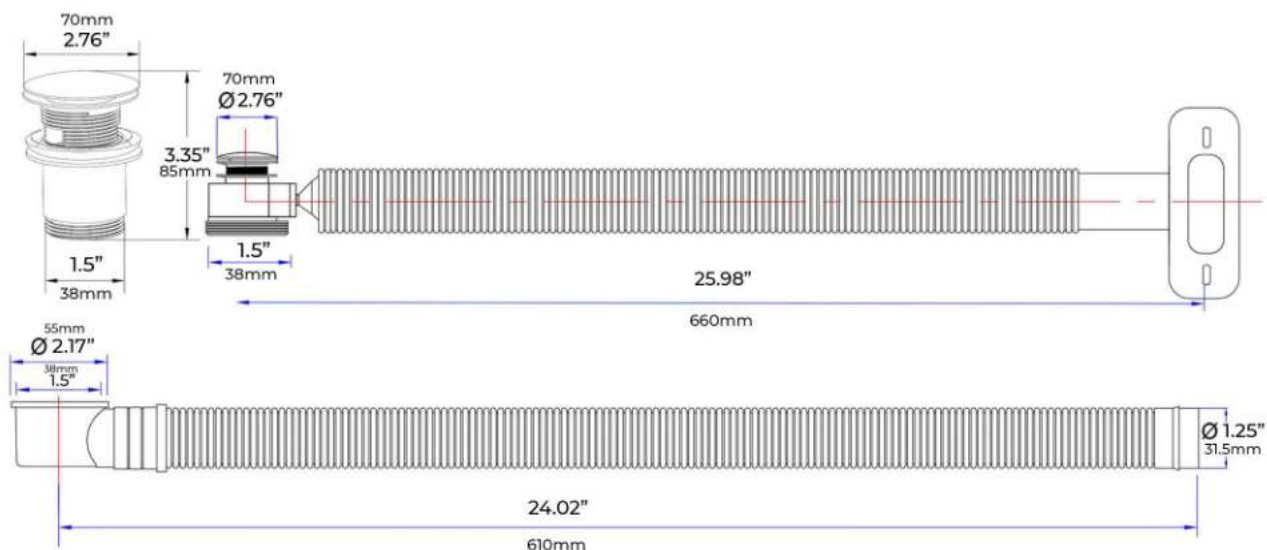

**XX REPRESENTS DIFFERENT COLORS OF THE ITEM

DRAIN D1040F-XX

HOW TO REMOVE THE OVERFLOW COVER:

If the chrome overflow cover is already pre-installed on your model, there are two simple ways to remove the cover.

1. Take a blade knife and carefully cut around the overflow. This will cut through the adhesive and allow the overflow cover to be removed.
2. Take a screwdriver and insert it into the overflow hole, applying pressure to pop out the overflow cover.

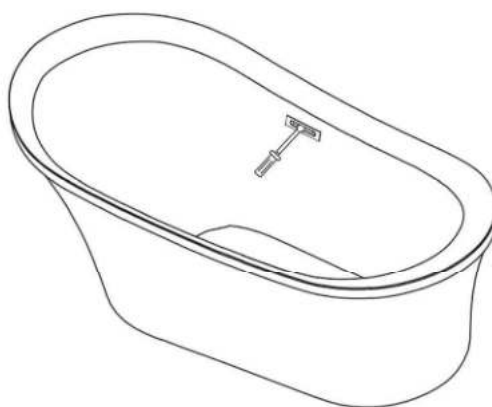
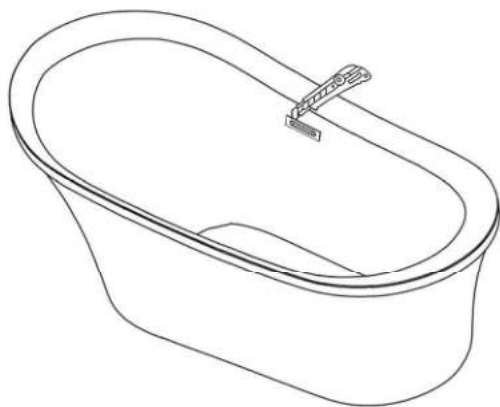

HOW TO INSTALL THE OVERFLOW COVER:

1. Put a bead of neutral cure silicone on the back of the overflow cover. Align with the overflow hole on the bathtub and stick on the bathtub. Press firmly. Wipe away any excess adhesive. Let it sit for at least 24 hours.

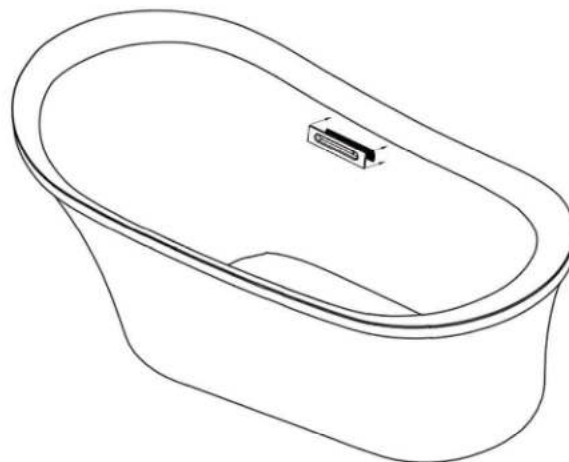

**XX REPRESENTS DIFFERENT COLORS OF THE ITEM

DRAIN D1040F-XX

HOW TO INSTALL THE DRAIN:

1. Unscrew the strainer from the drain tee that came in a separate box with your purchase.

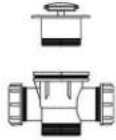

2. Take off the larger, lower rubber gasket. DO NOT TAKE OFF THE SMALLER, UPPER GASKET.

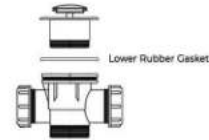

3. Place the strainer through the hole in the bathtub.

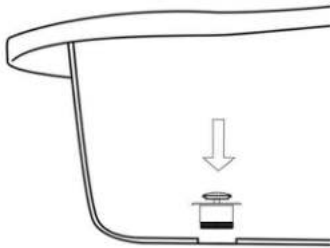

4. Take the lower gasket that was previously removed and re-attach it to the strainer from underneath the bathtub.

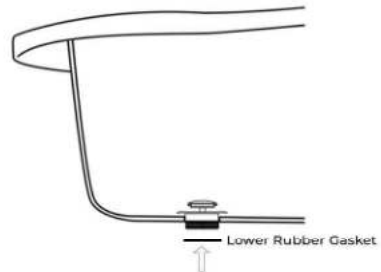

5. Take the drain tee and unscrew the right-handed side cap to connect to the overflow. There will be one gasket that you will remove to use to attach to the overflow drain. Set it aside for now.

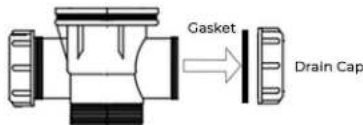

6. Take the drain tee and attach it to the strainer from underneath the bathtub. Tighten as much as possible.



7. Run the cap through the overflow hose and let it sit.

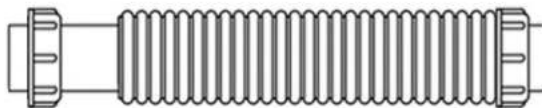

8. Take the rubber gasket that you had previously set aside and run it through up to the first ring on the overflow drain. Make sure that the gasket is put on inwards like so:

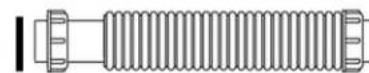

9. Attach the hose to the drain tee that was connected to the strainer in step 6. Tighten firmly. Check for any leakage prior to finalizing installation as there may be tightening that is required or re-attaching the gasket correctly. This is a critical step that cannot be skipped.

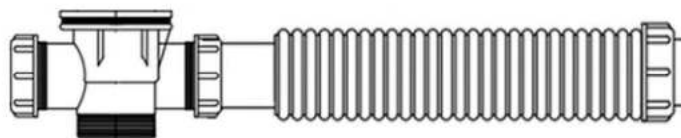

**XX REPRESENTS DIFFERENT COLORS OF THE ITEM

DRAIN D1040C-XX

HOW TO REMOVE THE OVERFLOW COVER:

1. Unscrew the round overflow cover. There will be a pin bolt that is visible. Unscrew the pin bolt and remove along with the overflow plate.

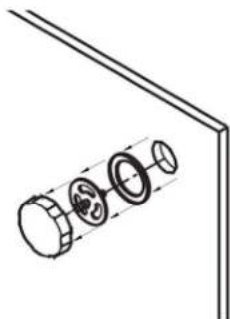

2. Please remove the large rubber gasket as well as the overflow drain from the back of the bathtub.

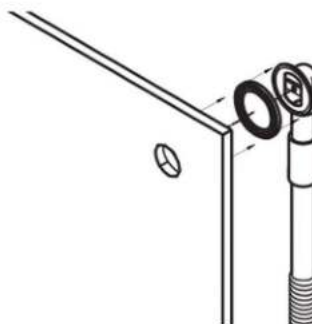

HOW TO INSTALL THE OVERFLOW COVER:

1. Unscrew the overflow cover, overflow plate, and pin bolt from the drain color of your choice.

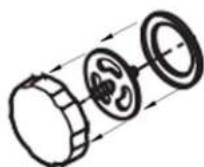

2. Take the overflow hose with the rubber gasket and attach it from the backside of the bathtub.

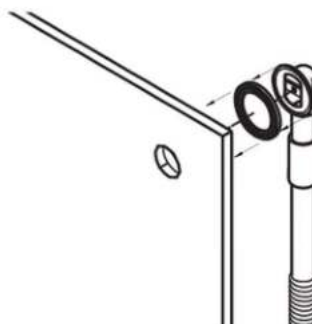

3. Take the overflow plate and place it over the overflow hole. Take the pin bolt and screw it inside to secure it. Take the round overflow cover and screw it onto the pin bolt.

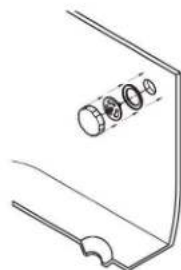

**XX REPRESENTS DIFFERENT COLORS OF THE ITEM

DRAIN D1040C-XX

HOW TO INSTALL THE DRAIN:

1. Unscrew the strainer from the drain tee that came in a separate box with your purchase.
2. Take off the larger, lower rubber gasket. DO NOT TAKE OFF THE SMALLER, UPPER GASKET.

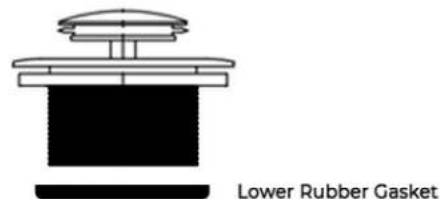

3. Place the strainer through the hole in the interior of the bathtub.
4. Take the lower gasket that was previously removed and re-attach it to the strainer from underneath the bathtub.

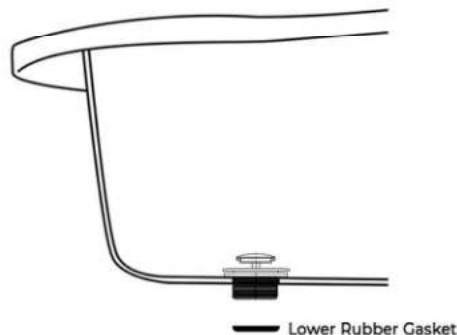
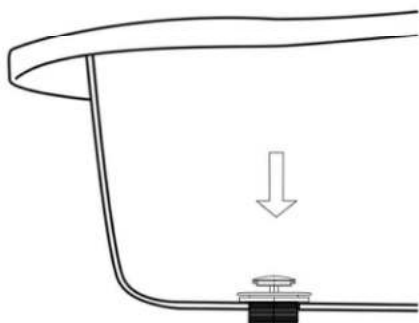

5. Take the tee and unscrew the right-handed side cap to connect to the overflow. There will be one gasket that you will remove to use to attach to the overflow drain. Set it aside for now.
6. Take the tee and attach it to the strainer from underneath the bathtub. Tighten as much as possible.

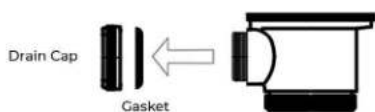

**XX REPRESENTS DIFFERENT COLORS OF THE ITEM